

ukn

Upgrade to simple

Structured cabling, reinvented.

FIBER

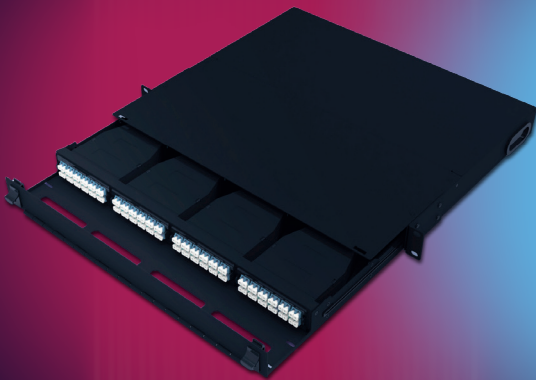

RACKS



COPPER

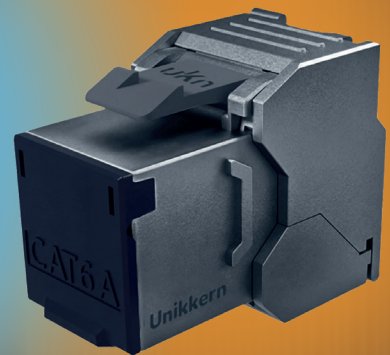

CATALOG

ukn
Unikkern

A brand of **syskern**

UNIKKERN

WHO ARE WE ?

● A BRAND BUILT ON EXPERIENCE

Unikkern is a brand of the French company **Syskern**, created by cabling experts with **over 20 years of industrial experience**.
Built on a strong technical heritage, the brand relies on deep expertise in **network infrastructures and critical environments**.

● WHO DO WE SERVE?

Unikkern develops solutions for users operating in demanding sectors: **modern workplaces, smart industry, high-performance data centers, and intelligent healthcare facilities**.

With a pragmatic approach, each solution is designed to address **real-world operational constraints**.

● OUR VISION

Our signature, “**Upgrade to simple**”, reflects our ambition to make network infrastructures **clearer, more efficient, and more sustainable**.

Upgrade to simple

Structured cabling, reinvented.

✓ AT A GLANCE



FRENCH DESIGN

A BRAND OF SYSKERN



CONNECTIVITY FOR DEMANDING ENVIRONMENTS

OFFICES, INDUSTRY, DATA CENTERS, HEALTHCARE, DEFENSE



CONTINUOUS INNOVATION

SIMPLE AND SCALABLE SOLUTIONS



CO-CREATION WITH OUR PARTNERS

SOLUTIONS DESIGNED WITH END USERS



OUR MODEL QUALITY, CONTROL, SUPPORT

● QUALITY AND LONG-TERM RELIABILITY

Reliability is at the core of Unikkern's commitments. All solutions benefit from a **30-year system warranty including all types of PoE**, reflecting product quality, rigorous industrial processes, and compliance with the **most demanding industry standards**.



● AN INTEGRATED VALUE CHAIN

Unikkern relies on a **fully integrated and controlled value chain** including technical expertise, industrial capabilities, quality control, logistics, and support. The presence of **local stock in France** ensures high responsiveness, short lead times, and optimal product availability.

● TAILORED SUPPORT

Beyond products, Unikkern provides **fast and responsive customer service** as well as **expert technical support**, delivering guidance and assistance throughout every project.



✓ **AT A GLANCE**

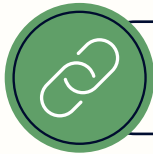

CONTROLLED VALUE CHAIN
FROM DESIGN TO DELIVERY



30-YEAR WARRANTY
A GUARANTEE OF RELIABILITY AND DURABILITY



LOCAL STOCK IN FRANCE
IMMEDIATE AVAILABILITY ACROSS A WIDE PRODUCT RANGE



FAST DELIVERY
OPTIMIZED LOGISTICS



TECHNICAL EXPERTISE & SUPPORT
GUIDANCE AT EVERY STAGE OF YOUR PROJECTS

OUR COMMITMENTS

CSR & CSRD

● RESPONSIBILITY & COMPLIANCE

As part of the Syskern group, Unikkern has implemented a CSR approach aligned with **the requirements of the CSRD directive**, covering its entire value chain: sourcing, production, logistics, packaging, and continuous improvement.



System-qualified production sites are certified to ISO 9001, ISO 14001 and ISO 45001, ensuring :

- rigorous quality management,
- a controlled reduction in environmental impacts,
- protection of employees' health and safety.

With a commitment to transparency and environmental performance, Syskern relies on **the Greenhouse Gas Protocol** to **quantify, manage, and reduce its carbon footprint**.

Emissions are assessed through **Life Cycle Assessments (LCA)**, enabling the preparation of **PEPs or EPDs**.



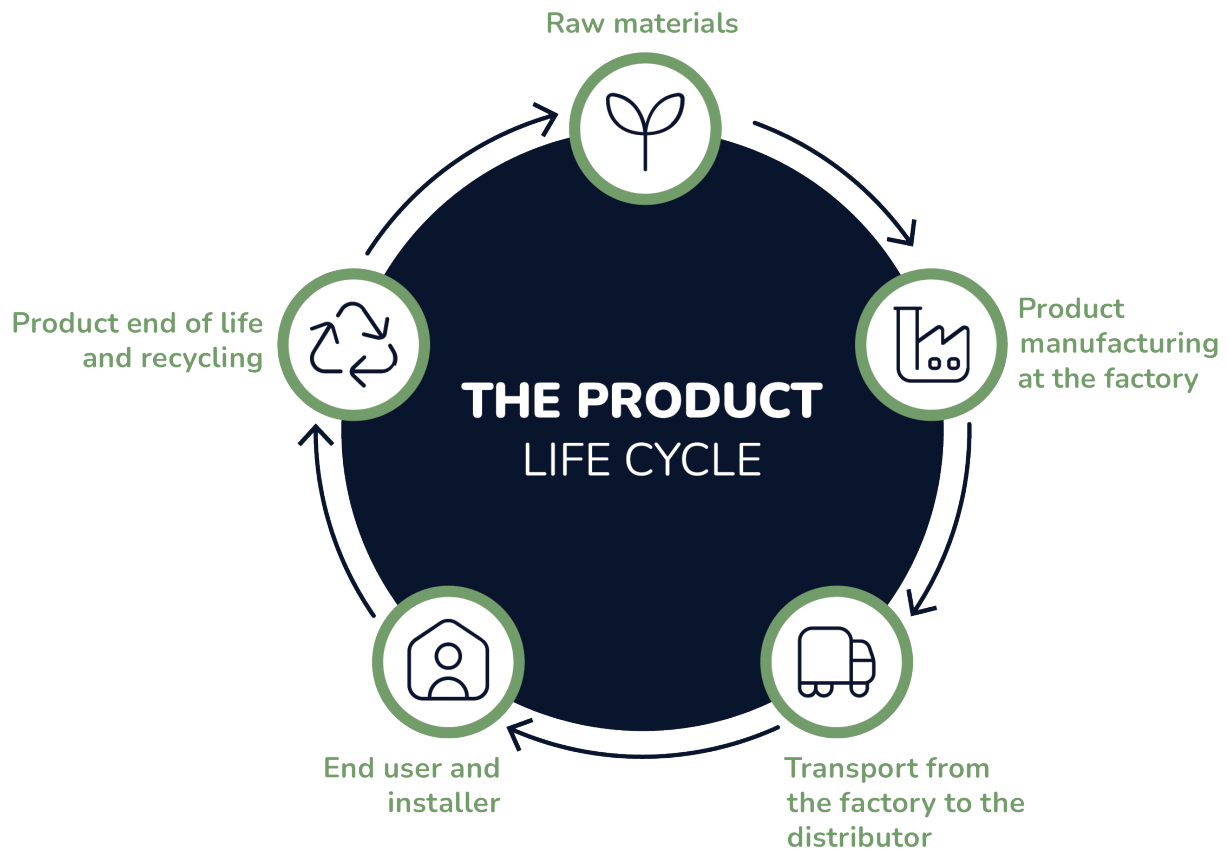

✔ AT A GLANCE

- **RESPONSIBLE AND CERTIFIED PRODUCTION**
ISO 9001, 14001 AND 45001 CERTIFIED SITES
- **MEASURED CARBON FOOTPRINT**
PRODUCT LIFE CYCLE ASSESSMENT (LCA, PEP, EPD)
- **ECO-DESIGN**
100% RECYCLED PACKAGING
- **CONTROLLED VALUE CHAIN**
FROM MANUFACTURING TO DELIVERY
- **ETHICS & TRANSPARENCY**
INTEGRITY, COMPLIANCE AND RESPONSIBLE BUSINESS RELATIONSHIPS

SUMMARY

FIBER

RACKS

COPPER

OPTICAL CABLE	<u>11</u>
HIGH DENSITY OPTICAL PANELS & TRUNKS	<u>26</u>
STANDARD OPTICAL PANELS	<u>29</u>
OPTICAL ACCESSORIES	<u>31</u>
ADAPTERS	<u>33</u>
PIGTAILS	<u>35</u>
OPTICAL PATCH CORDS	<u>37</u>
OPTICAL DISTRIBUTION BOXES	<u>41</u>
FREE STANDING CABINETS	<u>46</u>
WALL MOUNTED RACKS	<u>52</u>
CABINETS & RACKS ACCESSORIES	<u>57</u>
PANELS, SHELVES, DRAWERS	<u>62</u>
PDU	<u>70</u>
DATA CABLES	<u>72</u>
KEYSTONE JACK & ACCESSORIES	<u>100</u>
PATCH PANEL	<u>118</u>
FACE PLATES	<u>124</u>
PATCH CORDS	<u>130</u>

FIBER

OPTICAL CABLES	11
HIGH DENSITY OPTICAL PANEL & TRUNKS	26
STANDARD OPTICAL PANELS	29
OPTICAL ACCESSORIES	31
ADAPTERS	33
PIGTAILS	35
OPTICAL PATCH CORDS	37
OPTICAL DISTRIBUTION BOXES	41

KFOxxTBZHC

Tight buffered LSZH universal fiber optic cable



FIBER

RACKS & ACCESSORIES

COPPER

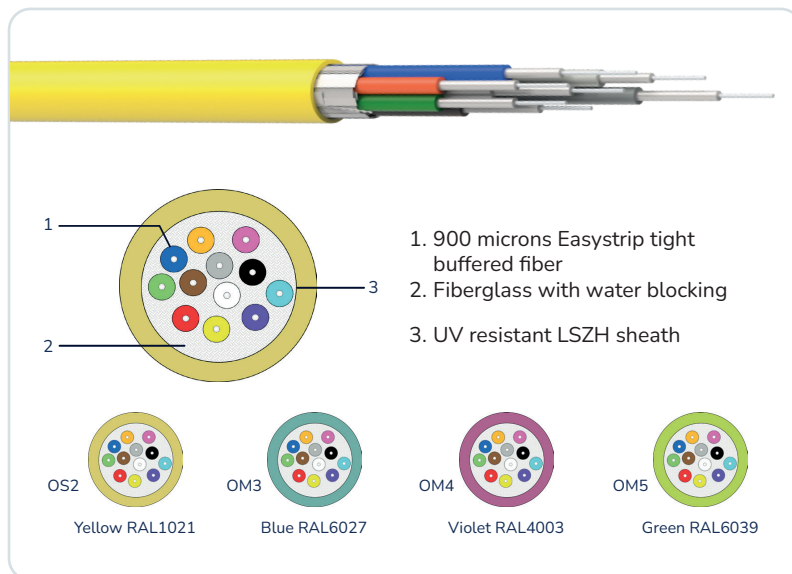

UNIK

- Compliant with ISO 11801 and IEC 60794 standards
- Good water resistance and UV protection
- LSZH jacket Cca (s1a, d0, a1) EN 50575



COMPLIANCE

Cable Standard

- IEC 60793 series Optical fibres
- IEC 60794-3 Outdoor optical fibre cables
- IEC 60794-1-21/22 Mechanical & environmental test methods

System

- IEC 60793-2-50 OM3, OM4 or OM5
- IEC 60793-2-50 B1.3 OS2
- ITU-T G.657.A2
- ISO/IEC 11801-1/Amd1:2025 OS2, OM3 or OM4

PURCHASE INFO

Nb of Fiber	Perf	Item	Item Code	Diameter (nom)	Weight (Kg)	Crush resistance (N/100mm)	Tensile strength(N)	Packaging
2	OS2	KFO2OS2TBZHC		4.0mm	22	1000	800 long term 1200 short term	D2000M / D4000M
4	OS2	KFO4OS2TBZHC		5.5mm	28	1000	800 long term 1200 short term	D2000M / D4000M
6	OS2	KFO6OS2TBZHC	U0807012	6.0mm	30	1000	800 long term 1200 short term	D2000M / D4000M
8	OS2	KFO8OS2TBZHC	U0807016	6.8mm	33	1000	800 long term 1200 short term	D2000M / D4000M
12	OS2	KFO12OS2TBZHC	U0807004	7.2mm	48	1000	800 long term 1200 short term	D2000M / D4000M
24	OS2	KFO24OS2TBZHC	U0807008	8.5mm	76	1000	1200 long term 1600 short term	D2000M / D4000M
2	OM3	KFO2OM3TBZHC		4.0mm	22	1000	800 long term 1200 short term	D2000M / D4000M
4	OM3	KFO4OM3TBZHC		5.5mm	28	1000	800 long term 1200 short term	D2000M / D4000M
6	OM3	KFO6OM3TBZHC	U0807009	6.0mm	30	1000	800 long term 1200 short term	D2000M / D4000M

KFOxxTBZHC

Tight buffered universal LSZH optical fiber cable



FIBER

RACKS & ACCESSORIES

COPPER

PURCHASE INFO

Nb of Fiber	Perf	Item	Item Code	Diameter (nom)	Weight (Kg)	Crush resistance (N/100mm)	Tensile strength(N)	Packaging
8	OM3	KFO80M3TBZHC	U0807013	6.8mm	33	1000	800 long term 1200 short term	D2000M / D4000M
12	OM3	KFO120M3TBZHC	U0807001	7.2mm	48	1000	800 long term 1200 short term	D2000M / D4000M
24	OM3	KFO240M3TBZHC	U0807005	8.5mm	76	1000	1200 long term 1600 short term	D2000M / D4000M
6	OM4	KFO60M4TBZHC	U0807010	6.0mm	30	1000	800 long term 1200 short term	D2000M / D4000M
8	OM4	KFO80M4TBZHC	U0807014	6.8mm	33	1000	800 long term 1200 short term	D2000M / D4000M
12	OM4	KFO120M4TBZHC	U0807002	7.2mm	48	1000	800 long term 1200 short term	D2000M / D4000M
24	OM4	KFO240M4TBZHC	U0807006	8.5mm	76	1000	800 long term 1200 short term	D2000M / D4000M
6	OM5	KFO60M5TBZHC	U0807011	6.0mm	30	1000	800 long term 1200 short term	D2000M / D4000M
8	OM5	KFO80M5TBZHC	U0807015	6.8mm	33	1000	800 long term 1200 short term	D2000M / D4000M
12	OM5	KFO120M5TBZHC	U0807003	7.2mm	48	1000	800 long term 1200 short term	D2000M / D4000M
24	OM5	KFO240M5TBZHC	U0807007	8.5mm	76	1000	1200 long term 1600 short term	D2000M / D4000M

KFOxxCTZHC

Central tube indoor & outdoor LSZH optical fiber cable

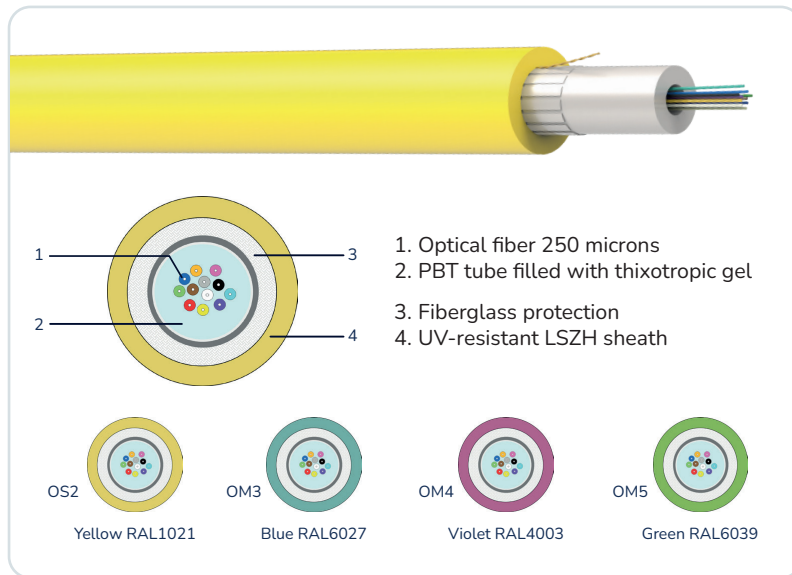

UNIK

- Compliant with ISO 11801 and IEC 60794 standards
- Excellent water resistance and UV protection
- LSZH jacket Cca (s1a, d0, a1) EN 50575



COMPLIANCE

Cable Standard

- IEC 60793 series Optical fibres
- IEC 60794-2/3 Indoor/Outdoor optical fibre cables
- IEC 60794-1-21/22 Mechanical & environmental test methods

System

- IEC 60793-2-50 OM3, OM4 or OM5
- IEC 60793-2-50 B1.3 OS2
- ITU-T G.657.A2
- ISO/IEC 11801-1/Amd1:2025 OS2, OM3 or OM4

PURCHASE INFO

Nb of Fiber	Nb of Tube	Perf	Item	Item Code	Diameter (nom)	Weight (Kg)	Crush resistance (N/100mm)	Tensile strength(N)	Packaging
6	1	OS2	KFO6OS2CTZHC	U0803023	6.5mm	50	1500	2000 long term 3200 short term	D4000M
8	1	OS2	KFO8OS2CTZHC		6.5mm	52	1500	2000 long term 3200 short term	D4000M
12	1	OS2	KFO12OS2CTZHC	U0803020	6.5mm	54	1500	2000 long term 3200 short term	D4000M
24	1	OS2	KFO24OS2CTZHC	U0803022	7.0mm	64	1500	2000 long term 3200 short term	D4000M
6	1	OM3	KFO6OM3CTZHC	U0803028	6.5mm	50	1500	2000 long term 3200 short term	D4000M
8	1	OM3	KFO8OM3CTZHC		6.5mm	52	1500	2000 long term 3200 short term	D4000M
12	1	OM3	KFO12OM3CTZHC	U0803019	6.5mm	54	1500	2000 long term 3200 short term	D4000M
24	1	OM3	KFOCT24OM3CTZHC	U0803021	7.0mm	64	1500	2000 long term 3200 short term	D4000M
6	1	OM4	KFO6OM4CTZHC	U0803024	6.5mm	50	1500	2000 long term 3200 short term	D4000M

KFOxxCTZHC

Central tube indoor & outdoor LSZH optical fiber cable



● PURCHASE INFO

Nb of Fiber	Nb of Tube	Perf	Item	Item Code	Diameter (nom)	Weight (Kg)	Crush resistance (N/100mm)	Tensile strength(N)	Packaging
8	1	OM4	KFO80M4CTZHC		6.5mm	52	1500	2000 long term 3200 short term	D4000M
12	1	OM4	KFO120M4CTZHC	U0803025	6.5mm	54	1500	2000 long term 3200 short term	D4000M
24	1	OM4	KFOCT240M4CTZHC	U0803027	7.0mm	64	1500	2000 long term 3200 short term	D4000M

ALSO AVAILABLE IN OM5 and G657A.2

KFOxxCT

Central tube outdoor PEHD optical fiber cable



FIBER

RACKS & ACCESSORIES

COPPER

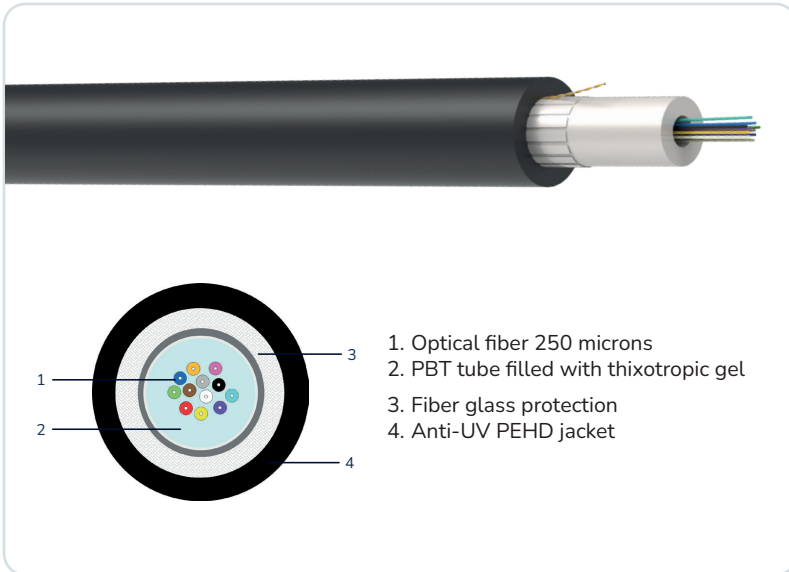

UNIK

- Complies with ISO 11801 and IEC 60794
- Very good waterproofing and UV resistance

COMPLIANCE

Cable Standard

- IEC 60793 series Optical fibres
- IEC 60794-3 Outdoor optical fibre cables
- IEC 60794-1-21/22 Mechanical & environmental test methods

System

- IEC 60793-2-50 OM3, OM4 or OM5
- IEC 60793-2-50 B1.3 OS2
- ITU-T G.657.A2
- ISO/IEC 11801-1/Amd1:2025 OS2, OM3 or OM4

PURCHASE INFO

Nb of Fiber	Nb of Tube	Perf	Item	Item Code	Diameter (nom)	Weight (Kg)	Crush resistance (N/100mm)	Tensile strength(N)	Packaging
6	1	OS2	KFO6OS2CT	U0802006	6.5mm	50	1500	2000 long term 3200 short term	D2000M/ D4000M
8	1	OS2	KFO8OS2CT	U0802008	6.5mm	52	1500	2000 long term 3200 short term	D2000M/ D4000M
12	1	OS2	KFO12OS2CT	U0802002	6.5mm	54	1500	2000 long term 3200 short term	D2000M/ D4000M
24	1	OS2	KFO24OS2CT	U0802004	7.0mm	64	1500	2000 long term 3200 short term	D2000M/ D4000M
6	1	OM3	KFO6OM3CT	U0802005	6.5mm	50	1500	2000 long term 3200 short term	D2000M/ D4000M
8	1	OM3	KFO8OM3CT	U0802007	6.5mm	52	1500	2000 long term 3200 short term	D2000M/ D4000M
12	1	OM3	KFO12OM3CT	U0802001	6.5mm	54	1500	2000 long term 3200 short term	D2000M/ D4000M
24	1	OM3	KFOCT24OM3CT	U0802003	7.0mm	64	1500	2000 long term 3200 short term	D2000M/ D4000M
6	1	OM4	KFO6OM4CT		6.5mm	50	1500	2000 long term 3200 short term	D2000M/ D4000M

KFOxxCT

Central tube outdoor PEHD optical fiber cable



FIBER

RACKS & ACCESSORIES

COPPER

PURCHASE INFO

Nb of Fiber	Nb of Tube	Perf	Item	Item Code	Diameter (nom)	Weight (Kg)	Crush resistance (N/100mm)	Tensile strength(N)	Packaging
8	1	OM4	KFO80M4CT		6.5mm	52	1500	2000 long term 3200 short term	D2000M/ D4000M
12	1	OM4	KFO120M4CT		6.5mm	54	1500	2000 long term 3200 short term	D2000M/ D4000M
24	1	OM4	KFOCT240M4CT		7.0mm	64	1500	2000 long term 3200 short term	D2000M/ D4000M

ALSO AVAILABLE IN OM5 and G657A.2

KFOxxCTA

Central tube armored outdoor PEHD optical fiber cable

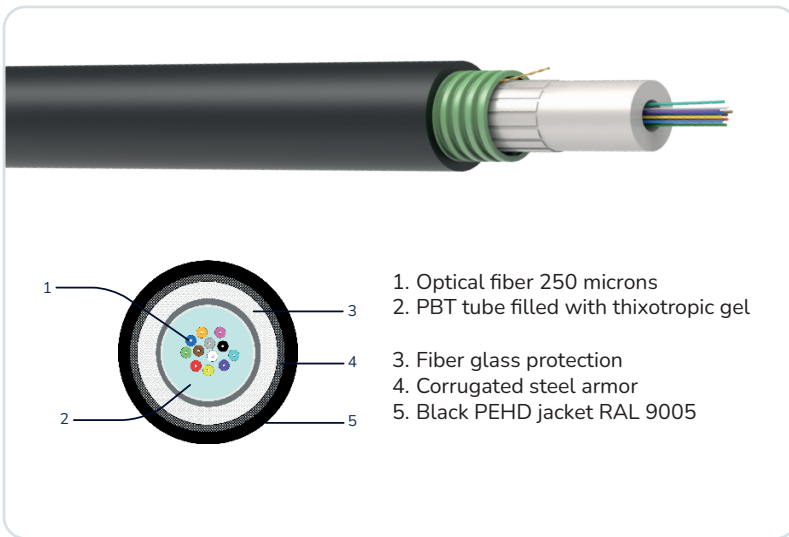

UNIK

- Complies with ISO 11801 and IEC 60794
- Excellent waterproofing and UV resistance
- The steel armor guarantees the anti-rodent protection

COMPLIANCE

Cable Standard

IEC 60793 series Optical fibres
 IEC 60794-3 Outdoor optical fibre cables
 IEC 60794-1-21/22 Mechanical & environmental test methods

System

IEC 60793-2-50 OM3, OM4 or OM5
 IEC 60793-2-50 B1.3 OS2
 ITU-T G.657.A2
 ISO/IEC 11801-1/Amd1:2025 OS2, OM3 or OM4

PURCHASE INFO

Nb of Fiber	Nb of Tube	Perf	Item	Item Code	Diameter (nom)	Weight (Kg)	Crush resistance (N/100mm)	Tensile strength(N)	Packaging
6	1	OS2	KFO6OS2CTA	U0801006	7.4mm	97	2000 long term	1600 long term 2700 Short term	D2000M/ D4000M
8	1	OS2	KFO8OS2CTA	U0801008	7.4mm	98	2000 long term	1600 long term 2700 Short term	D2000M/ D4000M
12	1	OS2	KFO12OS2CTA	U0801002	7.4mm	99	2000 long term	1600 long term 2700 Short term	D2000M/ D4000M
24	1	OS2	KFO24OS2CTA	U0801004	8.0mm	113	2000 long term	1600 long term 2700 Short term	D2000M/ D4000M
6	1	OM3	KFO6OM3CTA	U0801005	7.4mm	97	2000 long term	1600 long term 2700 Short term	D2000M/ D4000M
8	1	OM3	KFO8OM3CTA	U0801007	7.4mm	98	2000 long term	1600 long term 2700 Short term	D2000M/ D4000M
12	1	OM3	KFO12OM3CTA	U0801001	7.4mm	99	2000 long term	1600 long term 2700 Short term	D2000M/ D4000M
24	1	OM3	KFO24OM3CTA	U0801003	8.0mm	113	2000 long term	1600 long term 2700 Short term	D2000M/ D4000M

ALSO AVAILABLE IN OM4, OM5 and G657A.2

KFOxxCTAZHB2

Central tube armored indoor & outdoor LSZH optical fiber cable



RACKS & ACCESSORIES

COPPER

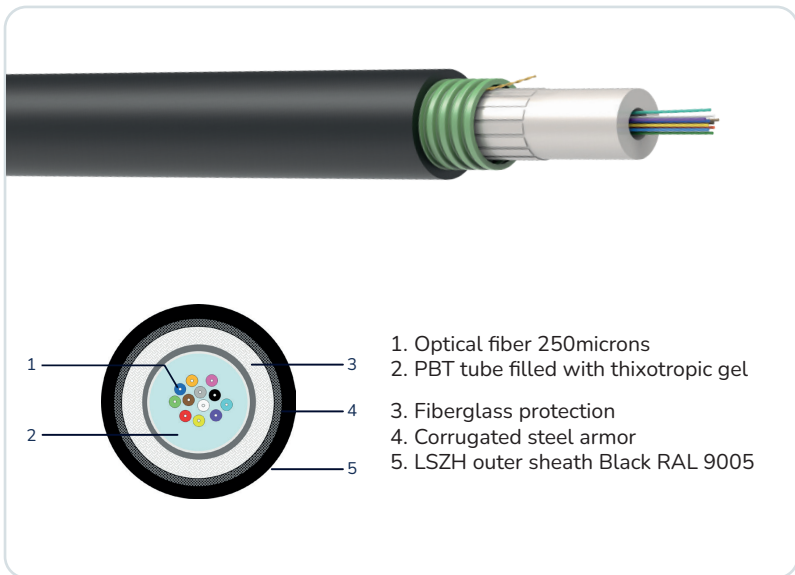

UNIK

- Complies with ISO 11801 and IEC 60794
- Very good waterproofing and UV resistance
- The steel armor guarantees the antirodent property
- LSZH jacket B2ca (s1a, d0, a1) EN 50575

COMPLIANCE

Cable Standard

- IEC 60793 series Optical fibres
- IEC 60794-2/3 Indoor/Outdoor optical fibre cables
- IEC 60794-1-21/22 Mechanical & environmental test methods

System

- IEC 60793-2-50 OM3, OM4 or OM5
- IEC 60793-2-50 B1.3 OS2
- ITU-T G.657.A2
- ISO/IEC 11801-1/Amd1:2025 OS2, OM3 or OM4

PURCHASE INFO

Nb of Fiber	Nb of Tube	Perf	Item	Item Code	Diameter (nom)	Weight (Kg)	Crush resistance (N/100mm)	Tensile strength(N)	Packaging
6	1	OS2	KFO6OS2CTAZHB2		7.5mm	92	2000 long term	1600 long term 2700 short term	D2000M/ D4000M
8	1	OS2	KFO8OS2CTAZHB2		7.5mm	93	2000 long term	1600 long term 2700 short term	D2000M/ D4000M
12	1	OS2	KFO12OS2CTAZHB2	U0801012	7.5mm	95	2000 long term	1600 long term 2700 short term	D2000M/ D4000M
24	1	OS2	KFO24OS2CTAZHB2	U0801013	8.0mm	99	2000 long term	1600 long term 2700 short term	D2000M/ D4000M
6	1	OM4	KFO6OM4CTAZHB2		7.5mm	92	2000 long term	1600 long term 2700 short term	D2000M/ D4000M
8	1	OM4	KFO8OM4CTAZHB2		7.5mm	93	2000 long term	1600 long term 2700 short term	D2000M/ D4000M
12	1	OM4	KFO12OM4CTAZHB2	U0801010	7.5mm	95	2000 long term	1600 long term 2700 short term	D2000M/ D4000M
24	1	OM4	KFO24OM4CTAZHB2	U0801011	8.0mm	99	2000 long term	1600 long term 2700 short term	D2000M/ D4000M

ALSO AVAILABLE IN OM3, OM5 and G657A.2

KFOxxCTAZHB2FR

Central tube armored indoor & outdoor LSZH fire resistant optical fiber cable



FIBER

RACKS & ACCESSORIES

COPPER

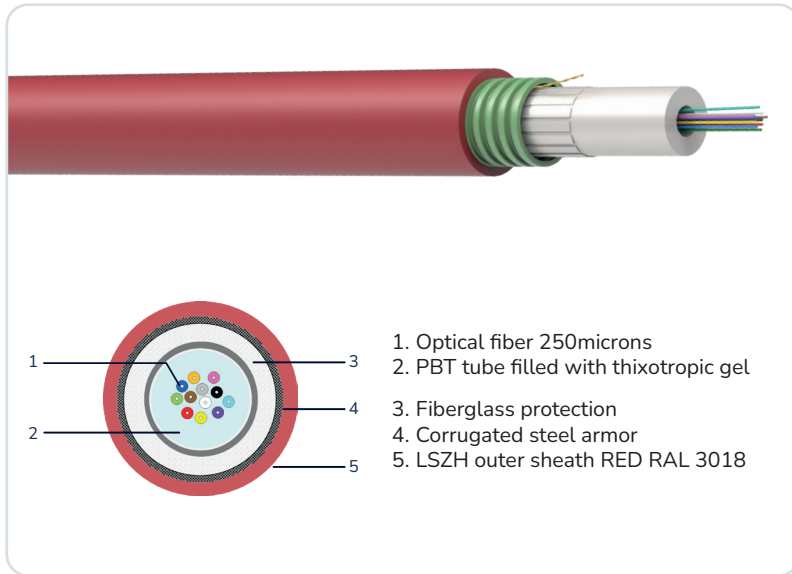

UNIK

- IEC331-25 (FE180) and EN 50200 (PH120)
- Complies with ISO 11801 and IEC 60794
- Very good waterproofing and UV resistance
- The steel armor guarantees the antirodent property
- LSZH jacket B2ca (s1a, d0, a1) EN 50575

COMPLIANCE

Cable Standard

- IEC 60793 series Optical fibres
- IEC 60794-2/3 Indoor/Outdoor optical fibre cables
- IEC 60794-1-21/22 Mechanical & environmental test methods

System

- IEC 60793-2-50 OM3, OM4 or OM5
- IEC 60793-2-50 B1.3 OS2
- ITU-T G.657.A2
- ISO/IEC 11801-1/Amd1:2025 OS2, OM3 or OM4

PURCHASE INFO

Nb of Fiber	Nb of Tube	Perf	Item	Item Code	Diameter (Nom)	Weight (Kg)	Crush resistance (N/100mm)	Tensile strength(N)	Packaging
6	1	OS2	KFO6OS2CTAZHB2FR	X	7.5mm	92	2000 long term	1600 long term 2700 short term	D2000M/ D4000M
8	1	OS2	KFO8OS2CTAZHB2FR	X	7.5mm	93	2000 long term	1600 long term 2700 short term	D2000M/ D4000M
12	1	OS2	KFO12OS2CTAZHB2FR	X	7.5mm	95	2000 long term	1600 long term 2700 short term	D2000M/ D4000M
24	1	OS2	KFO24OS2CTAZHB2FR	X	8.0mm	99	2000 long term	1600 long term 2700 short term	D2000M/ D4000M
6	1	OM3	KFO6OM3CTAZHB2FR	X	7.5mm	92	2000 long term	1600 long term 2700 short term	D2000M/ D4000M
8	1	OM3	KFO8OM3CTAZHB2FR	X	7.5mm	93	2000 long term	1600 long term 2700 short term	D2000M/ D4000M
12	1	OM3	KFO12OM3CTAZHB2FR	X	7.5mm	95	2000 long term	1600 long term 2700 short term	D2000M/ D4000M
24	1	OM3	KFO24OM3CTAZHB2FR	X	8.0mm	99	2000 long term	1600 long term 2700 short term	D2000M/ D4000M

ALSO AVAILABLE IN OM4, OM5 and G657A.2

KFOxxMTZHC

Multitube indoor & outdoor LSZH optical fiber cable

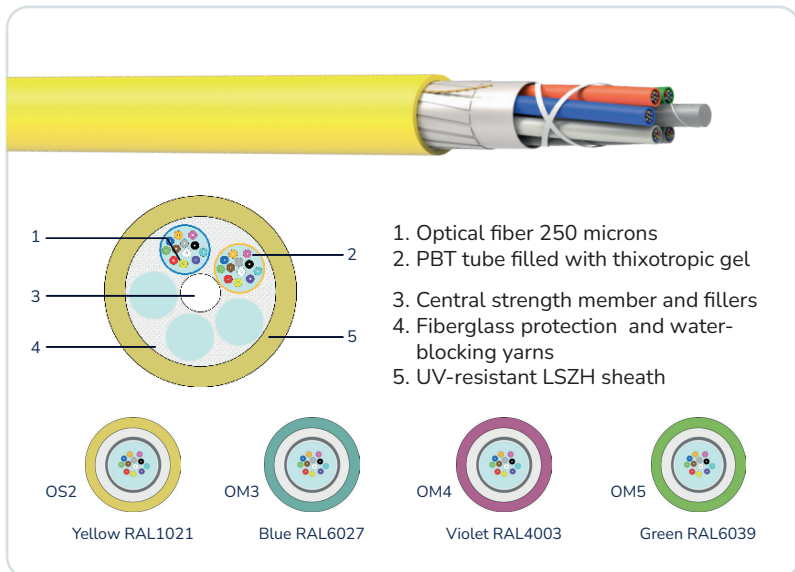

UNIK

- Compliant with ISO 11801 and IEC 60794
- Excellent water resistance and UV protection
- LSZH jacket Cca (s1a, d0, a1) EN 50575



COMPLIANCE

Cable Standard

- IEC 60793 series Optical fibres
- IEC 60794-3 Outdoor optical fibre cables
- IEC 60794-1-21/22 Mechanical & environmental test methods

System

- IEC 60793-2-50 OM3, OM4 or OM5
- IEC 60793-2-50 B1.3 OS2
- ITU-T G.657.A2
- ISO/IEC 11801-1/Amd1:2025 OS2, OM3 or OM4

PURCHASE INFO

Nb of Fiber	Nb of Tube	Perf	Item	Item Code	Diameter (nom)	Weight (Kg)	Crush resistance (N/100mm)	Tensile strength(N)	Packaging
24	2	OS2	KFO24OS2MTZHC		10.2mm	110	2000 long term	1600 long term 2700 short term	D2000M/ D4000M
48	4	OS2	KFO48OS2MTZHC	U0806009	10.2mm	110	2000 long term	1600 long term 2700 short term	D2000M/ D4000M
72	6	OS2	KFO72OS2MTZHC		10.2mm	110	2000 long term	1600 long term 2700 short term	D2000M/ D4000M
96	8	OS2	KFO96OS2MTZHC		11.5mm	135	2000 long term	1600 long term 2700 short term	D2000M/ D4000M
144	12	OS2	KFO144OS2MTZHC		16.0mm	210	2000 long term	1600 long term 2700 short term	D2000M/ D4000M

ALSO AVAILABLE IN OM3, OM4, OM5 and G657A.2

KFOxxMT

Multitube outdoor PEHD optical fiber cable



FIBER

RACKS & ACCESSORIES

COPPER

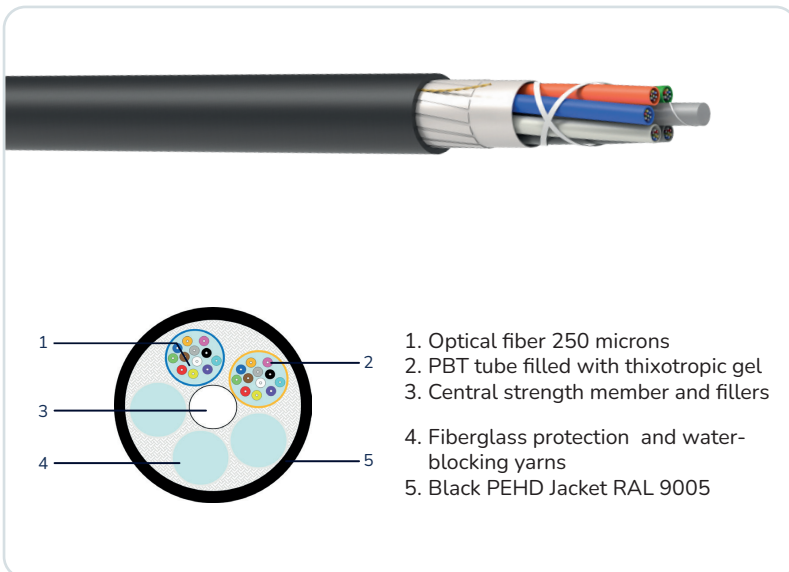

UNIK

- Compliant with ISO 11801 and IEC 60794 standards
- Excellent water resistance and UV protection
- Robust construction against rodents

COMPLIANCE

Cable Standard

- IEC 60793 series Optical fibres
- IEC 60794-3 Outdoor optical fibre cables
- IEC 60794-1-21/22 Mechanical & environmental test methods

System

- IEC 60793-2-50 OM3, OM4 or OM5
- IEC 60793-2-50 B1.3 OS2
- ITU-T G.657.A2
- ISO/IEC 11801-1/Amd1:2025 OS2, OM3 or OM4

PURCHASE INFO

Nb of Fiber	Nb of Tube	Perf	Item	Item Code	Diameter (nom)	Weight (Kg)	Crush resistance (N/100mm)	Tensile strength(N)	Packaging
12	1	OS2	KFO12OS2MT		10.2mm	110	3000 long term 4000 short term	2000 long term 3600 short term	D2000M/ D4000M
24	2	OS2	KFO24OS2MT		10.2mm	110	3000 long term 4000 short term	2000 long term 3600 short term	D2000M/ D4000M
48	4	OS2	KFO48OS2MT	U0805003	10.2mm	110	3000 long term 4000 short term	2000 long term 3600 short term	D2000M/ D4000M
72	6	OS2	KFO72OS2MT		10.2mm	110	3000 long term 4000 short term	2000 long term 3600 short term	D2000M/ D4000M
96	8	OS2	KFO96OS2MT	U0805006	11.5mm	135	3000 long term 4000 short term	2000 long term 3600 short term	D2000M/ D4000M
144	12	OS2	KFO144OS2MT		16.0mm	210	3000 long term 4000 short term	2000 long term 3600 short term	D2000M/ D4000M

ALSO AVAILABLE IN OM3, OM4, OM5 and G657A.2

KFOxxMTA

Multitube armored outdoor PEHD optical fiber cable

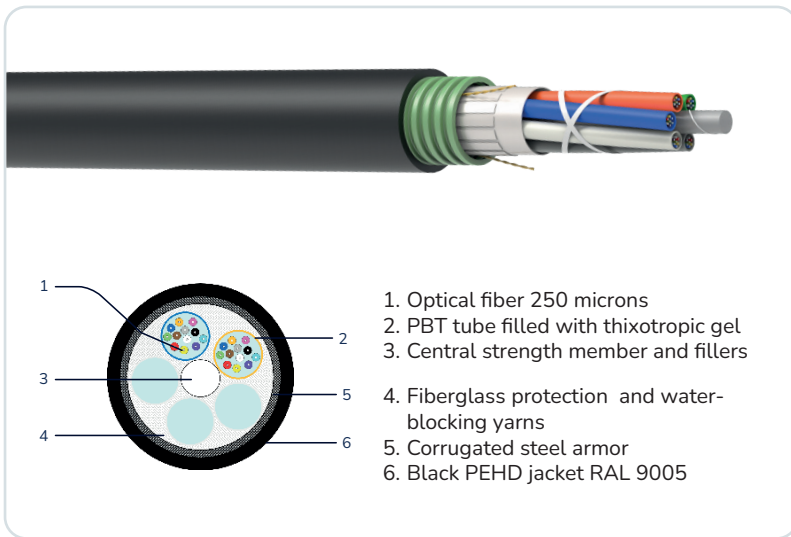

1. Optical fiber 250 microns
2. PBT tube filled with thixotropic gel
3. Central strength member and fillers
4. Fiberglass protection and water-blocking yarns
5. Corrugated steel armor
6. Black PEHD jacket RAL 9005

UNIK

- Complies with ISO 11801 and IEC 60794
- Very good waterproofing and UV resistance
- The steel armor guarantees the antirodent property

COMPLIANCE

Cable Standard

- IEC 60793 series Optical fibres
- IEC 60794-3 Outdoor optical fibre cables
- IEC 60794-1-21/22 Mechanical & environmental test methods

System

- IEC 60793-2-50 OM3, OM4 or OM5
- IEC 60793-2-50 B1.3 OS2
- ITU-T G.657.A2
- ISO/IEC 11801-1/Amd1:2025 OS2, OM3 or OM4

PURCHASE INFO

Nb of Fiber	Nb of Tube	Perf	Item	Item Code	Diameter (nom)	Weight (Kg)	Crush resistance (N/100mm)	Tensile strength(N)	Packaging
24	2	OS2	KFO24OS2MTA		12.0mm	140	3000 long term 4000 short term	2000 long term 3600 short term	D2000M/ D4000M
48	4	OS2	KFO48OS2MTA	U0804003	12.0mm	140	3000 long term 4000 short term	2000 long term 3600 short term	D2000M/ D4000M
72	6	OS2	KFO72OS2MTA		12.0mm	140	3000 long term 4000 short term	2000 long term 3600 short term	D2000M/ D4000M
96	8	OS2	KFO96OS2MTA	U0804006	14.0mm	180	3000 long term 4000 short term	2000 long term 3600 short term	D2000M/ D4000M
144	12	OS2	KFO144OS2MTA		18.0mm	220	3000 long term 4000 short term	2000 long term 3600 short term	D2000M/ D4000M

ALSO AVAILABLE IN OM3, OM4, OM5 and G657A.2

KFOxxMTAZHB2

Multitube armored indoor & outdoor LSZH optical fiber cable

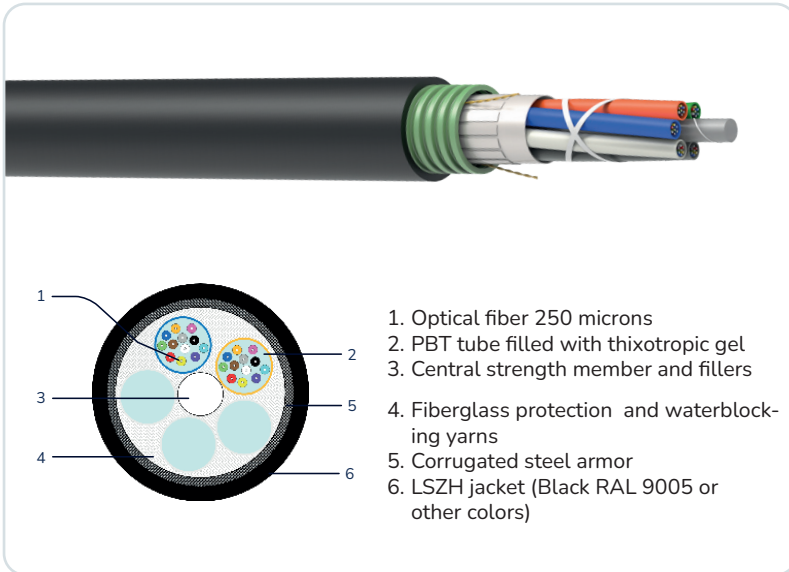

1. Optical fiber 250 microns
2. PBT tube filled with thixotropic gel
3. Central strength member and fillers
4. Fiberglass protection and waterblocking yarns
5. Corrugated steel armor
6. LSZH jacket (Black RAL 9005 or other colors)

UNIK

- Compliant with ISO 11801 and IEC 60794 standards
- Excellent waterproofing and UV resistance
- Steel armor provides anti-rodent protection
- LSZH jacket B2ca (s1a, d0, a1) EN 50575

COMPLIANCE

Cable Standard

IEC 60793 series Optical fibres
 IEC 60794-2/3 Indoor/Outdoor optical fibre cables
 IEC 60794-1-21/22 Mechanical & environmental test methods

System

IEC 60793-2-50 OM3, OM4 or OM5
 IEC 60793-2-50 B1.3 OS2
 ITU-T G.657.A2
 ISO/IEC 11801-1/Amd1:2025 OS2, OM3 or OM4

PURCHASE INFO

Nb of Fiber	Nb of Tube	Perf	Item	Item Code	Diameter (nom)	Weight (Kg)	Crush resistance (N/100mm)	Tensile strength(N)	Packaging
24	2	OS2	KFO24OS2MTAZHB2		12.0mm	140	3000 long term 4000 short term	2000 long term 3600 short term	D2000M/ D4000M
48	4	OS2	KFO48OS2MTAZHB2		12.0mm	140	3000 long term 4000 short term	2000 long term 3600 short term	D2000M/ D4000M
72	6	OS2	KFO72OS2MTAZHB2		12.0mm	140	3000 long term 4000 short term	2000 long term 3600 short term	D2000M/ D4000M
96	8	OS2	KFO96OS2MTAZHB2		14.0mm	180	3000 long term 4000 short term	2000 long term 3600 short term	D2000M/ D4000M
144	12	OS2	KFO144OS2MTAZHB2		18.0mm	220	3000 long term 4000 short term	2000 long term 3600 short term	D2000M/ D4000M

ALSO AVAILABLE IN OM3, OM4, OM5 and G657A.2

KFOxxMTZHAZHB2



Multitube armored indoor & outdoor double jacket LSZH optical fiber cable

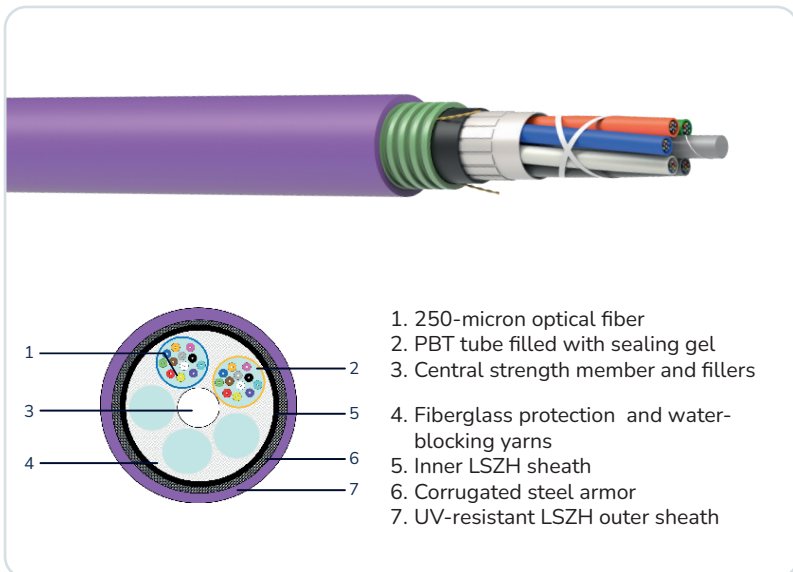

UNIK

- Compliant with ISO 11801 and IEC 60794 standards
- Excellent water resistance and UV protection
- Steel armor ensures anti-rodent properties
- LSZH jacket B2ca (s1a, d0, a1) EN 50575

COMPLIANCE

Cable Standard

- IEC 60793 series Optical fibres
- IEC 60794-2/3 Indoor/Outdoor optical fibre cables
- IEC 60794-1-21/22 Mechanical & environmental test methods

System

- IEC 60793-2-50 OM3, OM4 or OM5
- IEC 60793-2-50 B1.3 OS2
- ITU-T G.657.A2
- ISO/IEC 11801-1/Amd1:2025 OS2, OM3 or OM4

PURCHASE INFO

Nb of Fiber	Nb of Tube	Perf	Item	Item Code	Diameter (nom)	Weight (Kg)	Crush resistance (N/100mm)	Tensile strength(N)	Packaging
12	2	OS2	KFO12OS2MTZHAZHB2	U0809001	14.0mm	170	3000 long term 4000 short term	2000 long term 3600 short term	D2000M/ D4000M
24	2	OS2	KFO24OS2MTZHAZHB2	U0809002	14.0mm	170	3000 long term 4000 short term	2000 long term 3600 short term	D2000M/ D4000M
48	4	OS2	KFO48OS2MTZHAZHB2	U0809003	14.0mm	170	3000 long term 4000 short term	2000 long term 3600 short term	D2000M/ D4000M
72	6	OS2	KFO72OS2MTZHAZHB2		14.0mm	170	3000 long term 4000 short term	2000 long term 3600 short term	D2000M/ D4000M
96	8	OS2	KFO96OS2MTZHAZHB2		17.75mm	210	3000 long term 4000 short term	2000 long term 3600 short term	D2000M/ D4000M
144	12	OS2	KFO144OS2MTZHAZHB2		20.0mm	210	3000 long term 4000 short term	2000 long term 3600 short term	D2000M/ D4000M

ALSO AVAILABLE IN OM3, OM4, OM5 and G657A.2

KFOxxMTZHAZHB2FR

Multitube armored indoor & outdoor double jacket LSZH optical fiber cable



FIBER

RACKS & ACCESSORIES

COPPER

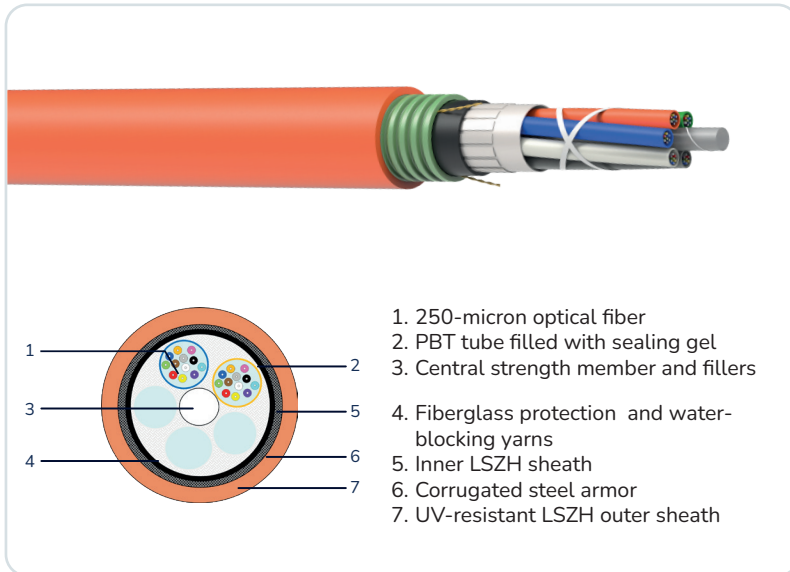

UNIK

- IEC331-25 (FE180) and EN 50200 (PH120) Compliant with ISO 11801 and IEC 60794 standards
- Excellent water resistance and UV protection
- Steel armor ensures anti-rodent properties
- LSZH jacket B2ca (s1a, d0, a1) EN 50575



COMPLIANCE

Cable Standard

- IEC 60793 series Optical fibres
- IEC 60794-2/3 Indoor/Outdoor optical fibre cables
- IEC 60794-1-21/22 Mechanical & environmental test methods

System

- IEC 60793-2-50 OM3, OM4 or OM5
- IEC 60793-2-50 B1.3 OS2
- ITU-T G.657.A2
- ISO/IEC 11801-1/Amd1:2025 OS2, OM3 or OM4

PURCHASE INFO

Nb of Fiber	Nb of Tube	Perf	Item	Item Code	Diameter (nom)	Weight (Kg)	Crush resistance (N/100mm)	Tensile strength(N)	Packaging
12	2	OS2	KFO12OS2MTZHAZHB2FR		14.0mm	170	3000 long term 4000 short term	2000 long term 3600 short term	D2000M/ D4000M
24	2	OS2	KFO24OS2MTZHAZHB2FR		14.0mm	170	3000 long term 4000 short term	2000 long term 3600 short term	D2000M/ D4000M
48	4	OS2	KFO48OS2MTZHAZHB2FR		14.0mm	170	3000 long term 4000 short term	2000 long term 3600 short term	D2000M/ D4000M
72	6	OS2	KFO72OS2MTZHAZHB2FR		14.0mm	170	3000 long term 4000 short term	2000 long term 3600 short term	D2000M/ D4000M
96	8	OS2	KFO96OS2MTZHAZHB2FR		17.75mm	210	3000 long term 4000 short term	2000 long term 3600 short term	D2000M/ D4000M
144	12	OS2	KFO144OS2MTZHAZHB2FR		20.0mm	210	3000 long term 4000 short term	2000 long term 3600 short term	D2000M/ D4000M

ALSO AVAILABLE IN OM3, OM4, OM5 and G657A.2

KSLI1UHMxx

Slim optical patch panel 19 inches 1U up to 144 fibers with side cable guides

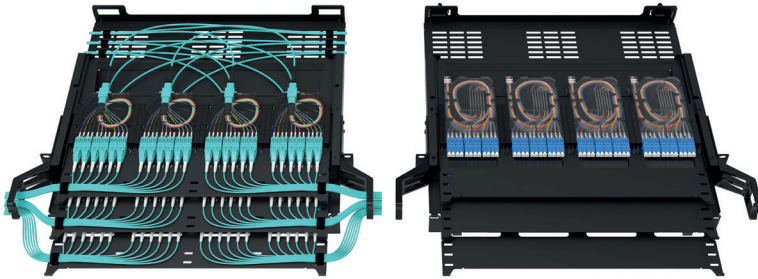

Cassette MPO or MTP



Cassette slim with splicing option

UNIK

- 144-fiber high density in 1U with three independent modular levels
- Modular architecture supporting MPO/ MTP or splice cassettes
- Integrated end-cord guides for optimized cable management
- Full sliding drawer access without disturbing adjacent connections

PURCHASE INFO

Item	Item Code	Designation	Packaging
KSLI1UHM	U1001038	19" optical patch panel SLIM 1U Slim up to 144 fibers with side cable guides	Eco-box of 1p
KSLIM12LCDOM3		Fusion Splice Cassette for SLIM optical patch panel LCD OM3, 12 fibers	Eco-box of 1p
KSLIM12LCDOM4	U0701004	Fusion Splice Cassette for SLIM optical patch panel LCD OM4, 12 fibers	Eco-box of 1p
KSLIM12LCDOS2		Fusion Splice Cassette for SLIM optical patch panel LCD OS2, 12 fibers	Eco-box of 1p
KSLIMTP12LCDOM3		MTP Cassette for SLIM optical patch panel LCD OM3, 12 fibers (Male)	Eco-box of 1p
KSLIMTP12LCDOM4		MTP Cassette for SLIM optical patch panel LCD OM4, 12 fibers (Male)	Eco-box of 1p
KSLIMTP12LCDOS2		MTP Cassette for SLIM optical patch panel LCD OS2, 12 fibers (Male)	Eco-box of 1p
KSLIMOBT	U1001039	Blank module for SLIM optical patch panel	Eco-box of 1p

KSFP1UHMxx

Hybrid Modular optical patch panel 19 inches 1U up to 96 fibers



FIBER

RACKS & ACCESSORIES

COPPER

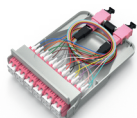

Cassette MPO or MTP



LCD module



SCS module



Keystone module

UNIK

- High modularity through 4 independent layers
- Available modules for all types of adapters including copper
- Easy routing managements in front and back panel
- Multiple options of cabling installation

PURCHASE INFO

Item	Item Code	Designation	Packaging
KSFP1UHM		19"Hybrid Modular Optical Patch Panel 1U up to 96 fibers	Eco-box of 1p
KSFPALCD12OM3		Module Adapter with 12 LC duplex OM3	Eco-box of 1p
KSFPALCD12OM4		Module Adapter with 12 LC duplex OM4	Eco-box of 1p
KSFPALCD12OS2		Module Adapter with 12 LC duplex OS2	Eco-box of 1p
KSFPASC8		Module Adapter for 8 SC (unloaded)	Eco-box of 1p
KSFPAST6		Module Adapter for 6 ST (unloaded)	Eco-box of 1p
KSFPARJ6		Module 6 units RJ45 (unloaded)	Eco-box of 1p
KSCMTP12LCDOM3		MTP Cassette for HYBRID optical patch panel LCD OM3, 12 fibers (Male)	Eco-box of 1p
KSCMTP12LCDOM4		MTP Cassette for HYBRID optical patch panel LCD OM4, 12 fibers (Male)	Eco-box of 1p
KSCMTP12LCDOS2		MTP Cassette for HYBRID optical patch panel LCD OS2, 12 fibers (Male)	Eco-box of 1p

KTRxxxxOxx

MPO-MPO 12 & 24 Fibers Trunk Cable



KTR12xxOxx



KTR24xxOxx

UNIK

- High fiber density
- Low loss performance
- Plug and play installation
- Integrated Mounting Clips

COMPLIANCE

Fiber cable according to IEC61754-7
Telcordia GR-326-Core

End surface test is according to TIA 604-5
EIA/TIA -455-21A

ROHS compliant

PURCHASE INFO

Item	Item Code	Designation	Packaging
KTR12xxOxx		MPO-MPO Trunk 12 fibers (Length to define)	Eco-friendly paper bag 1 pc
KTR24xxOxx		MPO-MPO Trunk 24 fibers (Length to define)	Eco-friendly paper bag 1 pc

AVAILABLE IN OS2, OM3, OM4

KSFP1UxxxNPCEF



Optical patch panel 19 inches 1U unloaded with accessories -
User-friendly fixture 205 or 245 mm depth

UNIK

- Available in two depth 205mm or 245mm
- Different front plate : ST, SC simplex/LC duplex, SC duplex/LC Quad
- Accessories kit included
- User-friendly fixture system with pre-cut mounting holes

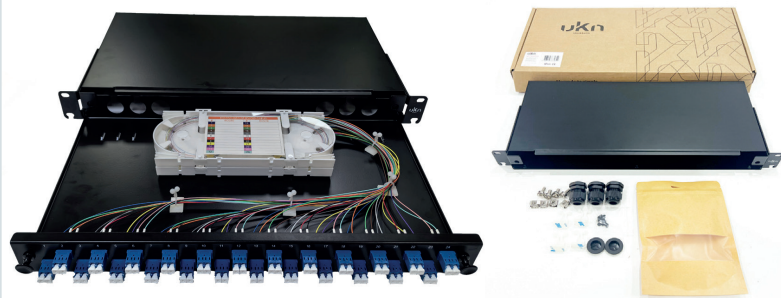

Example of configuration :

- Delivered empty + unloaded front plate
- Delivered empty + loaded front plate
- Fully loaded and ready to splice

PURCHASE INFO

Item	Item Code	Designation	Packaging
KSFP1U205NPCEF	U1001001	19" optical patch panel 205mm 1U without front plate - user friendly fixture and accessories kit - Eco friendly carton	Eco-box of 1p
KSFP1U245NPCEF	U1001002	19" optical patch panel 245mm 1U without front plate - user friendly fixture and accessories kit - Eco friendly carton	Eco-box of 1p
KSFP1UFP24SCDEF	U1001015	19" 1U Panel front plate 24 SC duplex (unloaded)	Eco-box of 1p
KSFP1UFP24SCSEF	U1001016	19" 1U Panel front plate 24 SC simplex (unloaded)	Eco-box of 1p
KSFP1UFP12SCDEF	U1001004	19" 1U Panel front plate 12 SC duplex (unloaded)	Eco-box of 1p
KSFP1UFP12SCSEF	U1001005	19" 1U Panel front plate 12 SC simplex (unloaded)	Eco-box of 1p
KSFP1UFP24STEF	U1001018	19" 1U Panel front plate 24 ST (unloaded)	Eco-box of 1p
KSFP1UFP2424SCDSEF	U1001014	19" 1U Panel front plate 24 SC duplex/LC quad equipped with 24 SC duplex singlemode	Eco-box of 1p
KSFP1UFP2412SCDSEF	U1001010	19" 1U Panel front plate 24 SC duplex/LC quad equipped with 12 SC duplex singlemode	Eco-box of 1p
KSFP1UFP2424LCDSEF	U1001012	19" 1U Panel front plate 24 LC duplex equipped with 24 LC duplex singlemode	Eco-box of 1p
KSFP1UFP2412LCDSEF	U1001008	19" 1U Panel front plate 24 LC duplex equipped with 12 LC duplex singlemode	Eco-box of 1p

KSFP1UxxxNPCEF

Optical patch panel 19 inches 1U unloaded with accessories - User-friendly fixture 205 or 245 mm depth

FIBER

RACKS & ACCESSORIES

COPPER

PURCHASE INFO

Item	Item Code	Designation	Packaging
KSFP1UFP2424SCDMEF	U1001013	19" 1U Panel front plate 24 SC duplex/LC quad equipped with 24 SC duplex multimode	Eco-box of 1p
KSFP1UFP2412SCDMEF	U1001009	19" 1U Panel front plate 24 SC duplex/LC quad equipped with 12 SC duplex multimode	Eco-box of 1p
KSFP1UFP2424LCDMEF	U1001011	19" 1U Panel front plate 24 LC duplex equipped with 24 LC duplex multimode	Eco-box of 1p
KSFP1UFP2412LCDMEF	U1001007	19" 1U Panel front plate 24 LC duplex equipped with 12 LC duplex multimode	Eco-box of 1p
KSFP1U2424SCDSEF		19" 1U Optical patch panel 24 SC duplex equipped with 24 SC duplex singlemode	Eco-box of 1p
KSFP1U2412SCDSEF		19" 1U Optical patch panel 24 SC duplex equipped with 12 SC duplex singlemode	Eco-box of 1p
KSFP1U2424LCDSEF	U1001031	19" 1U Optical patch panel 24 LC duplex equipped with 24 LC duplex singlemode	Eco-box of 1p
KSFP1U2412LCDSEF	U1001032	19" 1U Optical patch panel 24 LC duplex equipped with 12 LC duplex singlemode	Eco-box of 1p
KSFP1U2424LCDSEF2	U1001027	19" 1U Optical patch panel 24 LC duplex staggered equipped with 24 LC duplex singlemode	Eco-box of 1p
KSFP1U2412LCDSEF2	U1001028	19" 1U Optical patch panel 24 LC duplex staggered equipped with 12 LC duplex singlemode	Eco-box of 1p
KSFP1U2424SCDMEF		19" 1U Optical patch panel 24 SC duplex equipped with 24 SC duplex multimode	Eco-box of 1p
KSFP1U2412SCDMEF		19" 1U Optical patch panel 24 SC duplex equipped with 12 SC duplex multimode	Eco-box of 1p
KSFP1U2424LCDMEF	U1001033	19" 1U Optical patch panel 24 LC duplex equipped with 24 LC duplex multimode	Eco-box of 1p
KSFP1U2412LCDMEF	U1001034	19" 1U Optical patch panel 24 LC duplex equipped with 12 LC duplex multimode	Eco-box of 1p
KSFP1U2424LCDMEF2	U1001029	19" 1U Optical patch panel 24 LC duplex staggered equipped with 24 LC duplex multimode	Eco-box of 1p
KSFP1U2412LCDMEF2	U1001030	19" 1U Optical patch panel 24 LC duplex staggered equipped with 12 LC duplex multimode	Eco-box of 1p

KSET24FO

Stackable splice trays for 24 heat shrinks

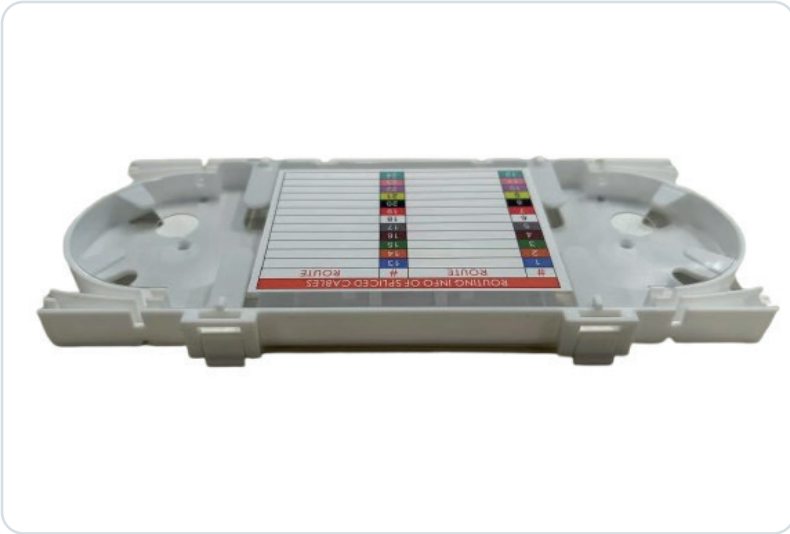

UNIK

- For up to 24 fiber and 24 fusion splices with 40/45mm or 60mm sleeves
- Facilitates and protects fusion connections using pigtails
- RoHs compliant

PURCHASE INFO

Item	Item Code	Designation	Packaging
KSET24FO	U0701002	Stackable splice trays for 24 heat shrinks	Eco bag of 1p

KSPlice60MM

Splice protection heat-shrink sleeves 60 mm

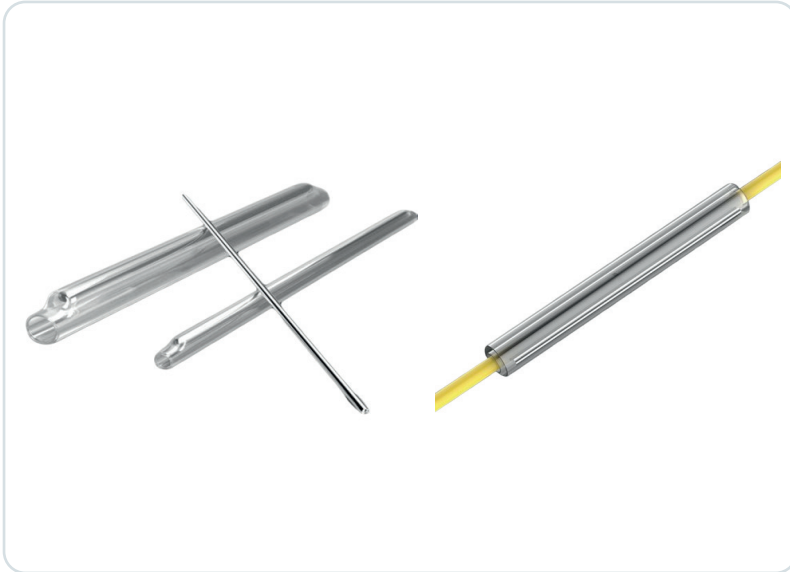

✓ UNIK

- Optimal protection
- Maintains optical properties
- Easy installation

● COMPLIANCE

Standard

CIBSETM65

System

BELLCORE GR1380
BS2056 & BS302526

ROHS compliant

2011/65/EU
(EU) 2015/863

● PURCHASE INFO

Item	Item Code	Designation	Packaging
KSPlice60MM	U0701001	Splice protection heat shrinks 60mm	Eco-box of 100pcs

KSASCDx

SC Duplex Adapter with short flange

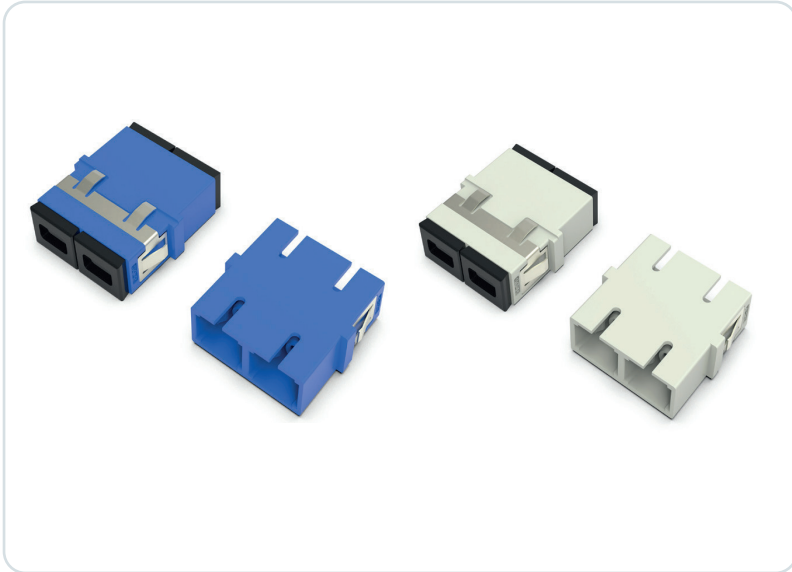

✓ UNIK

- Compact Design with short flange
- High-Precision Alignment
- Durable construction
- Integrated Mounting Clips

● PURCHASE INFO

Item	Item Code	Designation	Packaging
KSASCDM	U0601003	SC Duplex Multimode Adapter	Eco bag of 20pcs
KSASCDs	U0601004	SC Duplex Singlemode Adapter	Eco bag of 20pcs

KSALCDx

LC Duplex Adapter Twin Core with short flange

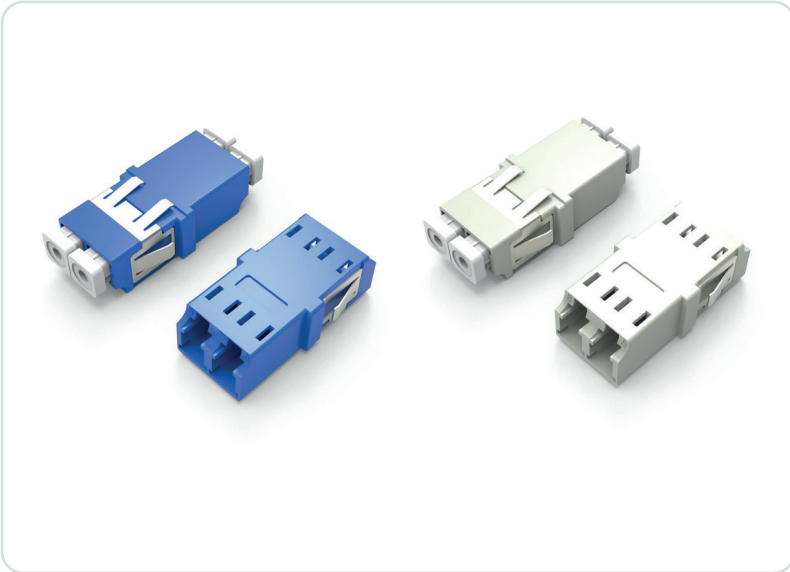

✓ UNIK

- Compact Design with short flange
- High-Precision Alignment
- Durable construction
- Integrated Mounting Clips

● PURCHASE INFO

Item	Item Code	Designation	Packaging
KSALCDM	U0601001	LC Duplex Multimode Adapter	Eco bag of 40pcs
KSALCDS	U0601002	LC Duplex Singlemode Adapter	Eco bag of 40pcs

KPIGOxxxx2MEF

Optical pigtail 2m LSZH Semi-Tight

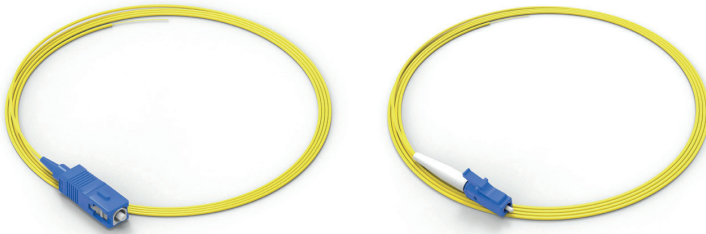

KPIGOS2SC2MEF

KPIGOS2LC2MEF

UNIK

- Individual packing
- Test report
- High quality construction
- ROHS compliant

COMPLIANCE

Fiber cable according to

IEC 60793-2-50 OM3, OM4 or OM5
 IEC 60793-2-50 B1.3 OS2
 ITU-T G.657.A2
 ISO/IEC 11801-1/Amd1:2025 OS2,
 OM3 or OM4

End surface test is according to

IEC 61754/ 60793
 EN 50173
Grade B connector end-face
 according to IEC 61300-3-35
 available upon request

ROHS compliant

2011/65/EU
 (EU) 2015/863

PURCHASE INFO

Item	Item Code	Designation	Packaging
KPIGOS2LC2MEF	U1104001	LC OS2 PIGTAIL 2m	Eco-friendly paper bag
KPIGOS2SC2MEF	U1104002	SC OS2 PIGTAIL 2m	Eco-friendly paper bag
KPIGOM3LC2MEF	U1101001	LC OM3 PIGTAIL 2m	Eco-friendly paper bag
KPIGOM3SC2MEF	U1101002	SC OM3 PIGTAIL 2m	Eco-friendly paper bag
KPIGOM4LC2MEF	U1102001	LC OM4 PIGTAIL 2m	Eco-friendly paper bag
KPIGOM5LC2MEF	U1103001	LC OM5 PIGTAIL 2m	Eco-friendly paper bag
KPIGOS2A2LC2MEF	U1104004	LC G657.A2 PIGTAIL 2m	Eco-friendly paper bag
KPIGOS2A2SC2MEF	U1104003	SC G657.A2 PIGTAIL 2m	Eco-friendly paper bag

KPIGOxxxxx2MEF

Optical pigtail 2m LSZH Semi-Tight



✓ UNIK

- Box of 12 colored pigtails packed in a protective carton box
- 12 Colors according to IEC304
- Test report
- High quality construction
- ROHS compliant

● COMPLIANCE

Fiber cable according to

IEC 60793-2-50 OM3, OM4 or OM5
 IEC 60793-2-50 B1.3 OS2
 ITU-T G.657.A2
 ISO/IEC 11801-1/Amd1:2025 OS2, OM3 or OM4

End surface test is according to

IEC61754/ 60793
 EN 50173
Grade B connector end-face according to IEC 61300-3-35 available upon request

ROHS compliant

2011/65/EU
 (EU) 2015/863

● PURCHASE INFO

Item	Item Code	Designation	Packaging
KPIG12OS2LC2MEF		LC OS2 PIGTAIL 2m	Eco-friendly paper bag
KPIG12OS2SC2MEF		SC OS2 PIGTAIL 2m	Eco-friendly paper bag
KPIG12OM3LC2MEF	U1101003	LC OM3 PIGTAIL 2m	Eco-friendly paper bag
KPIG12OM3SC2MEF	U1101004	SC OM3 PIGTAIL 2m	Eco-friendly paper bag
KPIG12OM4LC2MEF	U1102004	LC OM4 PIGTAIL 2m	Eco-friendly paper bag
KPIG12OM5LC2MEF		LC OM5 PIGTAIL 2m	Eco-friendly paper bag
KPIG12OS2A2LC2MEF	U1104004	LC G657.A2 PIGTAIL 2m	Eco-friendly paper bag
KPIG12OS2A2SC2MEF	U1104003	SC G657.A2 PIGTAIL 2m	Eco-friendly paper bag

KCDOxxSCxxMEF

Optical patchcords SC/SC or SC/LC DUPLEX LSZH



FIBER

RACKS & ACCESSORIES

COPPER

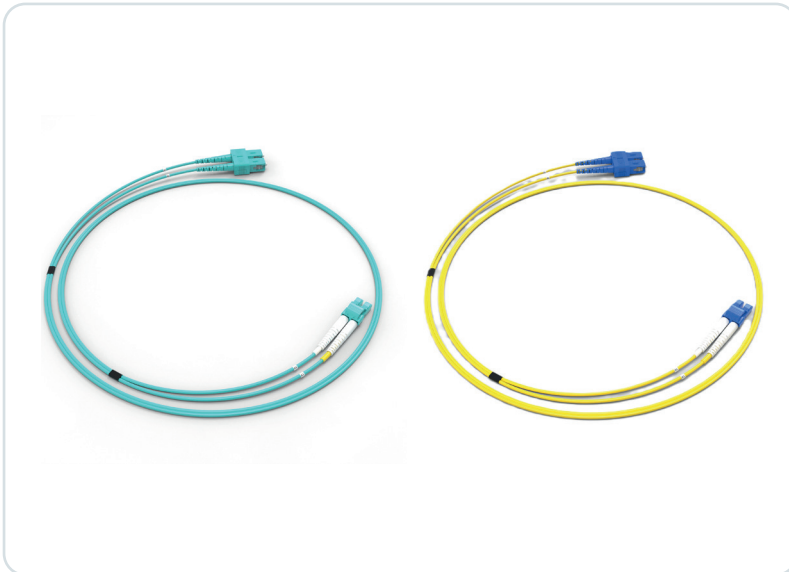

UNIK

- Low loss connectors
- Test report included
- Available in different lengths
- Compatible with all equivalent adapters
- Compact version 2.0mm outer diameter

COMPLIANCE

Fiber cable according to

IEC 60793-2-50 OM3, OM4 or OM5
 IEC 60793-2-50 B1.3 OS2
 ITU-T G.657.A2
 ISO/IEC 11801-1/Amd1:2025 OS2,
 OM3 or OM4

End surface test is according to

IEC 61300-3-35
 TIA / EIA 604-3, 568
 EN 50173

ROHS compliant

2011/65/EU
 (EU) 2015/863

Grade B connector end-face
 available upon request

PURCHASE INFO

Length	Item	Item Code	Description	Packaging
1m	KCDOS2SCSC1MEF		SC/SC OS2 DUPLEX OPTICAL PATCHCORD 1M	Eco-friendly paper bag
2m	KCDOS2SCSC2MEF		SC/SC OS2 DUPLEX OPTICAL PATCHCORD 2M	Eco-friendly paper bag
3m	KCDOS2SCSC3MEF		SC/SC OS2 DUPLEX OPTICAL PATCHCORD 3M	Eco-friendly paper bag
5m	KCDOS2SCSC5MEF		SC/SC OS2 DUPLEX OPTICAL PATCHCORD 5M	Eco-friendly paper bag
1m	KCDOM3SCSC1MEF		SC/SC OM3 DUPLEX OPTICAL PATCHCORD 1M	Eco-friendly paper bag
2m	KCDOM3SCSC2MEF		SC/SC OM3 DUPLEX OPTICAL PATCHCORD 2M	Eco-friendly paper bag
3m	KCDOM3SCSC3MEF		SC/SC OM3 DUPLEX OPTICAL PATCHCORD 3M	Eco-friendly paper bag
5m	KCDOM3SCSC5MEF		SC/SC OM3 DUPLEX OPTICAL PATCHCORD 3M	Eco-friendly paper bag

KCDOxxxLCLCxxMEF

Optical patchcords LC/LC DUPLEX LSZH

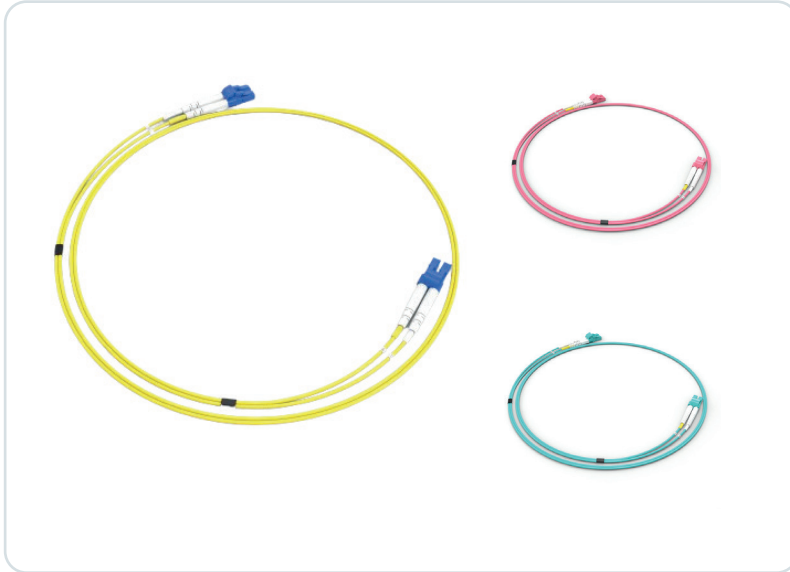

UNIK

- Low loss connectors
- Test report included
- Available in different lengths
- Compatible with all equivalent adapters
- Compact version 2.0mm outer diameter

COMPLIANCE

Fiber cable according to

IEC 60793-2-50 OM3, OM4 or OM5
 IEC 60793-2-50 B1.3 OS2
 ITU-T G.657.A2
 ISO/IEC 11801-1/Amd1:2025 OS2,
 OM3 or OM4

End surface test is according to

IEC 61300-3-35
 TIA / EIA 604-3, 568
 EN 50173

ROHS compliant

2011/65/EU
 (EU) 2015/863

Grade B connector end-face
 available upon request

PURCHASE INFO

Length	Item	Item Code	Description	Packaging
1m	KCDOS2LCLC1MEF	U0904001	LC/LC OS2 DUPLEX OPTICAL PATCHCORD 1M	Eco-friendly paper bag
2m	KCDOS2LCLC2MEF	U0904002	LC/LC OS2 DUPLEX OPTICAL PATCHCORD 2M	Eco-friendly paper bag
3m	KCDOS2LCLC3MEF	U0904003	LC/LC OS2 DUPLEX OPTICAL PATCHCORD 3M	Eco-friendly paper bag
5m	KCDOS2LCLC5MEF	U0904004	LC/LC OS2 DUPLEX OPTICAL PATCHCORD 5M	Eco-friendly paper bag
10m	KCDOS2LCLC10MEF	U0904020	LC/LC OS2 DUPLEX OPTICAL PATCHCORD 10M	Eco-friendly paper bag
1m	KCDOM3LCLC1MEF	U0901001	LC/LC OM3 DUPLEX OPTICAL PATCHCORD 1M	Eco-friendly paper bag
2m	KCDOM3LCLC2MEF	U0901002	LC/LC OM3 DUPLEX OPTICAL PATCHCORD 2M	Eco-friendly paper bag
3m	KCDOM3LCLC3MEF	U0901003	LC/LC OM3 DUPLEX OPTICAL PATCHCORD 3M	Eco-friendly paper bag

KCDOxxxLCLCxxMEF

Optical patchcords LC/LC DUPLEX LSZH



PURCHASE INFO

Length	Item	Item Code	Description	Packaging
5m	KCDOM3LCLC5MEF	U0901004	LC/LC OM3 DUPLEX OPTICAL PATCHCORD 5M	Eco-friendly paper bag
10m	KCDOM3LCLC10MEF	U0901015	LC/LC OM3 DUPLEX OPTICAL PATCHCORD 10M	Eco-friendly paper bag
1m	KCDOM4LCLC1MEF	U0902001	LC/LC OM4 DUPLEX OPTICAL PATCHCORD 1M	Eco-friendly paper bag
2m	KCDOM4LCLC2MEF	U0902002	LC/LC OM4 DUPLEX OPTICAL PATCHCORD 2M	Eco-friendly paper bag
3m	KCDOM4LCLC3MEF	U0902003	LC/LC OM4 DUPLEX OPTICAL PATCHCORD 3M	Eco-friendly paper bag
5m	KCDOM4LCLC5MEF	U0902004	LC/LC OM4 DUPLEX OPTICAL PATCHCORD 5M	Eco-friendly paper bag
10m	KCDOM4LCLC10MEF	U0902015	LC/LC OM4 DUPLEX OPTICAL PATCHCORD 10M	Eco-friendly paper bag

KCDxxxLCLCxxUNIEF

Optical patchcords UNIBOOT LC/LC DUPLEX LSZH



UNIK

- Uniboot connector to save patching space
- Low loss connectors
- Test report included
- Available in different lengths and connector
- Compatible with all equivalent adapters
- Compact version 2.0mm outer diameter

COMPLIANCE

Fiber cable according to

IEC 60793-2-50 OM3, OM4 or OM5
 IEC 60793-2-50 B1.3 OS2
 ITU-T G.657.A2
 ISO/IEC 11801-1/Amd1:2025 OS2,
 OM3 or OM4

End surface test is according to

IEC 61300-3-35
 TIA / EIA 604-3, 568
 EN 50173

ROHS compliant

PURCHASE INFO

Length	Item	Item Code	Description	Packaging
1m	KCDOS2LCLC1UNIEF		UNIBOOT LC/LC OS2 DUPLEX OPTICAL PATCH-CORD 1M	Eco-friendly paper bag
2m	KCDOS2LCLC2UNIEF		UNIBOOT LC/LC OS2 DUPLEX OPTICAL PATCH-CORD 2M	Eco-friendly paper bag
3m	KCDOS2LCLC3UNIEF		UNIBOOT LC/LC OS2 DUPLEX OPTICAL PATCH-CORD 3M	Eco-friendly paper bag
5m	KCDOS2LCLC5UNIEF		UNIBOOT LC/LC OS2 DUPLEX OPTICAL PATCH-CORD 5M	Eco-friendly paper bag
1m	KCDOM4LCLC1UNIEF		UNIBOOT LC/LC OM4 DUPLEX OPTICAL PATCH-CORD 1M	Eco-friendly paper bag
2m	KCDOM4LCLC2UNIEF		UNIBOOT LC/LC OM4 DUPLEX OPTICAL PATCH-CORD 2M	Eco-friendly paper bag
3m	KCDOM4LCLC3UNIEF		UNIBOOT LC/LC OM4 DUPLEX OPTICAL PATCH-CORD 3M	Eco-friendly paper bag
5m	KCDOM4LCLC5UNIEF		UNIBOOT LC/LC OM4 DUPLEX OPTICAL PATCH-CORD 3M	Eco-friendly paper bag

KFDB04IP65

Optical outdoor IP65 distribution box 4 cores



UNIK

- Compact design
- Wet-proof, anti-aging, dust-proof
- IP grade 65
- Easy for maintenance and installation

PURCHASE INFO

Item	Item Code	Designation	Packing
KFDB04IP65		Optical outdoor IP65 distribution box 4 cores	Eco-box of 1p

KFDB08IP65

Optical outdoor IP65 distribution box 8 cores



UNIK

- Secure with anti-theft locking mechanism
- Good properties of dust, and moisture proofing IP65
- Protects and manages cable effectively
- Easy for maintenance and installation

PURCHASE INFO

Item	Item Code	Designation	Packing
KFDB08IP65		Optical outdoor IP65 distribution box 8 cores	Eco-box of 1p

KFDBO16IP65

Optical outdoor IP65 distribution box 16 cores



UNIK

- Protect and manages cable effectively
- Water-proof, wet-proof, anti-aging, dust-proof
- IP grade 65
- Easy for maintenance and installation
- Wall and Pole mountable

PURCHASE INFO

Item	Item Code	Designation	Packing
KFDBO16IP65		Optical outdoor IP65 distribution box 16 cores	Eco-box of 1p

KFDBO24IP65

Optical outdoor IP65 distribution box 24 cores



UNIK

- Strong design
- Water-proof,wet-proof, anti-aging, dust-proof
- IP grade 65
- Easy for maintenance and installation

PURCHASE INFO

Item	Item Code	Designation	Packing
KFDBO24IP65		Optical outdoor IP65 distribution box 24 cores	Eco-box of 1p

RACKS

FREE STANDING CABINETS	46
WALL MOUNTED RACKS CABINETS	52
CABINETS & RACKS ACCESSORIES	57
PANEL, SHELVES, DRAWERS	62
PDU	70

KRGxx10x

«GRID» 19 inch hybrid free standing network cabinet 1000mm width



Roof ventilation



Hinge with 180° opening



Ergonomic handle with EURO cylinder



3 points lock

UNIK

- Static load capacity up to 1.2 tons
- High density, 1000 mm depth compatible with deep servers and switches
- 180° front & rear door opening
- Sliding & brush cable entry
- Cable management & vertical organizer
- Sliding lock and O'Lock system for panels

Door option :

- “DG” double glass door
- “DP” double perforated (80%)
- “R” full metal rear panel
- “WDR” without front/back door
- “WP” without side panels

PURCHASE INFO

Item	Item Code	Units	Dimensions (mm)	Designation	Packaging
KRG321010DGR		32U	1000x1000	GRID 19" network cabinet, double front glass door and solid metal rear panel	1 Pc
KRG4210 10DGR		42U	1000x1000	GRID 19" network cabinet, double front glass door and solid metal rear panel	1 Pc
KRG471010DGR		47U	1000x1000	GRID 19" network cabinet, double front glass door and solid metal rear panel	1 Pc
KRG321010DP2		32U	1000x1000	GRID 19" network cabinet, double front and rear perforated doors	1 Pc
KRG421010DP2		42U	1000x1000	GRID 19" network cabinet, double front and rear perforated doors	1 Pc
KRG471010DP2		47U	1000x1000	GRID 19" network cabinet, double front and rear perforated doors	1 Pc

KRGxx8x

«GRID» 19 inch hybrid free standing network cabinet 800mm width



FIBER

RACKS & ACCESSORIES

COPPER



Roof ventilation



Hinge with 180° opening



Ergonomic handle with EURO cylinder



3 points lock

UNIK

- Static load capacity up to 1.2 tons
- High density
- 180° front & rear door opening
- Sliding & brush cable entry
- Cable management & vertical organizer
- Sliding lock and O'Lock system for panels

Door option :

- “SG” single glass door
- “DG” double glass door
- “DP” double perforated (80%)
- “R” full metal rear panel
- “WDR” without front/back door
- “WP” without side panels

PURCHASE INFO

Item	Item Code	Units	Dimensions (mm)	Designation	Packaging
KRG2488SGR		24U	800x800	GRID 19" network cabinet, single front glass door and solid metal rear panel	1 Pc
KRG2788SGR		27U	800x800	GRID 19" network cabinet, single front glass door and solid metal rear panel	1 Pc
KRG3288SGR		32U	800x800	GRID 19" network cabinet, single front glass door and solid metal rear panel	1 Pc
KRG3288DGR	U1403020	32U	800x800	GRID 19" network cabinet, double front glass door and solid metal rear panel	1 Pc
KRG3288DP2	U1403061	32U	800x800	GRID 19" network cabinet, double front and rear perforated doors	1 Pc
KRG4286SGR		42U	800x600	GRID 19" network cabinet, single front glass door and solid metal rear panel	1 Pc
KRG4286DGR	U1403019	42U	800x600	GRID 19" network cabinet, double front glass door and solid metal rear panel	1 Pc
KRG4286DP2	U1403060	42U	800x600	GRID 19" network cabinet, double front and rear perforated doors	1 Pc
KRG4288SGR		42U	800x800	GRID 19" network cabinet, single front glass door and solid metal rear panel	1 Pc
KRG4288DGR	U1403021	42U	800x800	GRID 19" network cabinet, double front glass door and solid metal rear panel	1 Pc
KRG4288DP2	U1403062	42U	800x800	GRID 19" network cabinet, double front and rear perforated doors	1 Pc
KRG42810SGR		42U	800x1000	GRID 19" network cabinet, single front glass door and solid metal rear panel	1 Pc

KRGxx8x

«GRID» 19 inch hybrid free standing network cabinet width 800mm



FIBER

RACKS & ACCESSORIES

COPPER

PURCHASE INFO

Item	Item Code	Units	Dimensions (mm)	Designation	Packaging
KRG42810DGR	U1403023	42U	800x1000	GRID 19" network cabinet, double front glass door and solid metal rear panel	1 Pc
KRG42810DP2	U1403064	42U	800x1000	GRID 19" network cabinet, double front and rear perforated doors	1 Pc
KRG42812SGR		42U	800x1200	GRID 19" network cabinet, single front glass door and solid metal rear panel	1 Pc
KRG42812DGR	U1403024	42U	800x1200	GRID 19" network cabinet, double front glass door and solid metal rear panel	1 Pc
KRG42812DP2	U1403066	42U	800x1200	GRID 19" network cabinet, double front and rear perforated doors	1 Pc
KRG4788SGR		47U	800x800	GRID 19" network cabinet, single front glass door and solid metal rear paneliii	1 Pc
KRG4788DGR	U1403022	47U	800x800	GRID 19" network cabinet, double front glass door and solid metal rear panel	1 Pc
KRG4788DP2	U1403063	47U	800x800	GRID 19" network cabinet, double front and rear perforated doors	1 Pc
KRG47810SGR		47U	800x1000	GRID 19" network cabinet, single front glass door and solid metal rear panel	1 Pc
KRG47810DGR		47U	800x1000	GRID 19" network cabinet, double front glass door and solid metal rear panel	1 Pc
KRG47810DP2	U1403065	47U	800x1000	GRID 19" network cabinet, double front and rear perforated doors	1 Pc
KRG47812SGR		47U	800x1200	GRID 19" network cabinet, single front glass door and solid metal rear panel	1 Pc
KRG47812DGR	U1403025	47U	800x1200	GRID 19" network cabinet, double front glass door and solid metal rear panel	1 Pc
KRG47812DP2	U1403067	47U	800x1200	GRID 19" network cabinet, double front and rear perforated doors	1 Pc

KRGxx6x

«GRID» 19 inch hybrid free standing network cabinet width 600mm



UNIK

- Static load capacity up to 1.2 tons
- High density
- 180° front & rear door opening
- Sliding & brush cable entry
- Cable management & vertical organizer
- Sliding lock and O'Lock system for panels

Door option :

- “SG” single glass door
- “SP” single perforated (80%)
- “R” full metal rear panel
- “WDR” without front/back door
- “WP” without side panels

PURCHASE INFO

Item	Item Code	Units	Dimensions (mm)	Designation	Packaging
KRG2266SGR	U1403001	22U	600x600	GRID 19" network cabinet, single front glass door and solid metal rear panel	1 Pc
KRG2466SGR	U1403002	24U	600x600	GRID 19" network cabinet, single front glass door and solid metal rear panel	1 Pc
KRG2766SGR	U1403003	27U	600x600	GRID 19" network cabinet, single front glass door and solid metal rear panel	1 Pc
KRG3266SGR	U1403004	32U	600x600	GRID 19" network cabinet, single front glass door and solid metal rear panel	1 Pc
KRG4266SGR	U1403005	42U	600x600	GRID 19" network cabinet, single front glass door and solid metal rear panel	1 Pc
KRG4266SP2	U1403046	42U	600x600	GRID 19" network cabinet, single front and rear perforated doors	1 Pc
KRG4268SGR	U1403008	42U	600x800	GRID 19" network cabinet, single front glass door and solid metal rear panel	1 Pc
KRG4268SP2	U1403049	42U	600x800	GRID 19" network cabinet, single front and rear perforated doors	1 Pc
KRG42610SGR	U1403009	42U	600x1000	GRID 19" network cabinet, single front glass door and solid metal rear panel	1 Pc
KRG42610SP2	U1403051	42U	600x1000	GRID 19" network cabinet, single front and rear perforated doors	1 Pc
KRG4768SGR		47U	600x800	GRID 19" network cabinet, single front glass door and solid metal rear panel	1 Pc
KRG4768SP2	U1403050	47U	600x800	GRID 19" network cabinet, single front and rear perforated doors	1 Pc

KRSxx8x

«Start» 19 inch hybrid free standing network cabinet width 800mm



FIBER

RACKS & ACCESSORIES

COPPER



UNIK

- Static load capacity up to 650 Kg
- Hinged doors
- Side panels with easy access
- Sliding lock and O'Lock system for panels including Euro cylinder

Door option :

- “SG” single glass door
- “DP” double perforated (80%)
- “R” full metal rear panel
- “WDR” without front/back door
- “WP” without side panels

PURCHASE INFO

Item	Item Code	Units	Dimensions (mm)	Designation	Packaging
KRS2488SGR		24U	800x800	“START” 19” network cabinet, single front glass door and solid metal rear panel	1 Pc
KRS2786SGR		27U	800x800	“START” 19” network cabinet, single front glass door and solid metal rear panel	1 Pc
KRS3288SGR		32U	800x800	“START” 19” network cabinet, single front glass door and solid metal rear panel	1 Pc
KRS4286SGR		42U	800x600	“START” 19-inch network cabinet with double front glass doors and rear panel	1 Pc
KRS4286DP2		42U	800x600	“START” 19” network cabinet, double front and rear perforated doors	1 Pc
KRS4288SGR	U1402023	42U	800x800	“START” 19” network cabinet, single front glass door and solid metal rear panel	1 Pc
KRS4288DP2		42U	800x800	“START” 19” network cabinet, double front and rear perforated doors	1 Pc
KRS42810SGR		42U	800x1000	“START” 19” network cabinet, single front glass door and solid metal rear panel	1 Pc
KRS42810DP2	U1402022	42U	800x1000	“START” 19” network cabinet, double front and rear perforated doors	1 Pc

KRSxx6x

«Start» 19 inch hybrid free standing network cabinet width 600mm



FIBER

RACKS & ACCESSORIES

COPPER



UNIK

- Static load capacity up to 650 Kg
- Hinged doors
- Side panels with easy access
- Sliding lock and O'Lock system for panels including Euro cylinder

Door option :

- “SG” single glass door
- “SP” single perforated (80%)
- “R” full metal rear panel
- “WDR” without front/back door
- “WP” without side panels

PURCHASE INFO

Item	Item Code	Units	Dimensions (mm)	Designation	Packaging
KRS2266SGR	U1402001	22U	600x600	“START” 19” network cabinet, single front glass door and solid metal rear panel	1 Pc
KRS2466SGR	U1402002	24U	600x600	“START” 19” network cabinet, single front glass door and solid metal rear panel	1 Pc
KRS2766SGR	U1402003	27U	600x600	“START” 19” network cabinet, single front glass door and solid metal rear panel	1 Pc
KRS2768SGR		27U	600x800	“START” 19” network cabinet, single front glass door and solid metal rear panel	1 Pc
KRS3266SGR	U1402004	32U	600x600	“START” 19” network cabinet, single front glass door and solid metal rear panel	1 Pc
KRS3268SGR		32U	600x800	S“START” 19” network cabinet, single front glass door and solid metal rear panel	1 Pc
KRS4266SGR	U1402005	42U	600x600	“START” 19” network cabinet, single front glass door and solid metal rear panel	1 Pc
KRS4266SP2		42U	600x600	GRID 19” network cabinet, single front and rear perforated doors	1 Pc
KRS4268SGR		42U	600x800	“START” 19” network cabinet, single front glass door and solid metal rear panel	1 Pc
KRS4268SP2		42U	600x800	GRID 19” network cabinet, single front and rear perforated doors	1 Pc
KRS42610SGR	U1402013	42U	600x1000	“START” 19” network cabinet, single front glass door and solid metal rear panel	1 Pc
KRS42610SP2		42U	600x1000	GRID 19” network cabinet, single front and rear perforated doors	1 Pc

KWGxxxxx

«Grid» 19 inch wall mounted rack



✓ UNIK

- Compact and Elegant
- Wall-mounting kit included for direct installation
- Robust steel frame (up to 60 kg load capacity)
- Galvanized 19 inch Front and Rear Rails
- Top Brush Cable Entry
- Passive Ventilation

● PURCHASE INFO

Item	Item Code	Unit	Dimensions	Designation	Packaging
KWG06450		6U	565x450	Grid wall mounted rack 19" 6U 450mm depth with glass front door	1 Pc
KWG09450		9U	565x450	Grid wall mounted rack 19" 9U 450mm depth with glass front door	1 Pc
KWG12450		12U	565x450	Grid wall mounted rack 19" 12U 450mm depth with glass front door	1 Pc
KWG15450		15U	565x450	Grid wall mounted rack 19" 15U 450mm depth with glass front door	1 Pc
KWG18450		18U	565x450	Grid wall mounted rack 19" 18U 450mm depth with glass front door	1 Pc
KWG22450	U1503007	22U	565x450	Grid wall mounted rack 19" 22U 450mm depth with glass front door	1 Pc
KWG06600		6U	565x600	Grid wall mounted rack 19" 6U 600mm depth with glass front door	1 Pc
KWG09600		9U	565x600	Grid wall mounted rack 19" 9U 600mm depth with glass front door	1 Pc
KWG12600	U1503002	12U	565x600	Grid wall mounted rack 19" 12U 600mm depth with glass front door	1 Pc
KWG15600		15U	565x600	Grid wall mounted rack 19" 15U 600mm depth with glass front door	1 Pc
KWG18600		18U	565x600	Grid wall mounted rack 19" 18U 600mm depth with glass front door	1 Pc
KWG22600	U1503010	22U	565x600	Grid wall mounted rack 19" 22U 600mm depth with glass front door	1 Pc

KWGxxxxx

«Grid» 19 inch wall mounted rack



PURCHASE INFO

Item	Item Code	Unit	Dimensions	Designation	Packaging
KWG09600FD	U1503001	9U	565x600	Grid wall mounted rack 9U 600mm with full front door	1 Pc
KWG9600PED		9U	565x600	Grid wall mounted rack 9U 600mm with perforated front door	1 Pc
KWG12600FD	U1503003	12U	565x600	Grid wall mounted rack 12U 600mm with full front door	1 Pc
KWG12600PED	U1503004	12U	565x600	Grid wall mounted rack 12U 600mm with perforated front door	1 Pc
KWG22450FD	U1503008	22U	565x450	Grid wall mounted rack 22U 450mm with full front door	1 Pc
KWG22450PED	U1503009	22U	565x450	Grid Cabinet 22U 450mm with perforated front door	1 Pc
KWG22600FD	U1503011	22U	565x600	Grid wall mounted rack 22U 600mm with full front door	1 Pc
KWG22600PED	U1503012	22U	565x600	Grid wall mounted rack 22U 600mm with perforated front door	1 Pc
KWGDOOR12FD	U1503006	12U		Full Door for 12U Grid Cabinet	1 Pc
KWGDOOR12PED	U1503005	12U		Perforated Door for 12U Grid Cabinet	1 Pc
KWGDOOR22FD	U1503013	22U		Full Door for 22U Grid Cabinet	1 Pc
KWGDOOR22PED	U1503014	22U		Perforated Door for 22U Grid Cabinet	1 Pc

KWAxxxxx

«Start» 19 inch wall mounted rack



UNIK

- Quick and intuitive assembly (installation in under 10 minutes)
- Steel frame (up to 45 kg load capacity)
- Tempered glass door with locking system
- Top and bottom cable entries for maximum flexibility
- Removable panels for easy maintenance

PURCHASE INFO

Item	Item Code	Unit	Dimensions	Designation	Packaging
KWA645F	U1502008	6U	570x450	Start wall mounted rack 19" 6U 450mm depth with glass front door - Flat pack	1 Pc
KWA945F	U1502009	9U	570x450	Start wall mounted rack 19" 9U 450mm depth with glass front door - Flat pack	1 Pc
KWA1245F	U1502010	12U	570x450	Start wall mounted rack 19" 12U 450mm depth with glass front door - Flat pack	1 Pc
KWA1545F	U1502011	15U	570x450	Start wall mounted rack 19" 15U 450mm depth with glass front door - Flat pack	1 Pc
KWA1845F	U1502012	18U	570x450	Start wall mounted rack 19" 18U 450mm depth with glass front door - Flat pack	1 Pc
KWA2245F	U1502013	22U	570x450	Start wall mounted rack 19" 22U 450mm depth with glass front door - Flat pack	1 Pc
KWA2745F	U1502014	27U	570x450	Start wall mounted rack 19" 27U 450mm depth with glass front door - Flat pack	1 Pc
KWA660F	U1502001	6U	570x600	Start wall mounted rack 19" 6U 600mm depth with glass front door - Flat pack	1 Pc
KWA960F	U1502002	9U	570x600	Start wall mounted rack 19" 9U 600mm depth with glass front door - Flat pack	1 Pc
KWA1260F	U1502003	12U	570x600	Start wall mounted rack 19" 12U 600mm depth with glass front door - Flat pack	1 Pc
KWA1560F	U1502004	15U	570x600	Start wall mounted rack 19" 15U 600mm depth with glass front door - Flat pack	1 Pc
KWA1860F	U1502005	18U	570x600	Start wall mounted rack 19" 18U 600mm depth with glass front door - Flat pack	1 Pc

KWAxxxxxx

«Start» 19 inch wall mounted rack



● PURCHASE INFO

Item	Item Code	Units	Dimensions (mm)	Designation	Packaging
KWA2260F	U1502006	22U	570x600	Start wall mounted rack 19" 22U 600mm depth with glass front door - flat pack	1 Pc
KWG2760F	U1502007	27U	570x600	Start wall mounted rack 19" 27U 600mm depth with glass front door - flat pack	1 Pc

KWIxxxxx

«IP55» 19 inch wall mounted rack



FIBER

RACKS & ACCESSORIES

COPPER



UNIK

- Excellent resistance to dust and water splashes
- Galvanized front and rear 19-inch rails
- Suitable for outdoor installations
- Passive ventilation
- High load capacity: 200 kg
- Compliant with IEC/EN 60529

PURCHASE INFO

Item	Item Code	Units	Dimensions (mm)	Designation	Packaging
KWI07600	U1504001	7U	600x600	Wall-mounted cabinet IP55 7U	1 Pc
KWI09600		9U	600x600	Wall-mounted cabinet IP55 9U	1 Pc
KWI12600		12U	600x600	Wall-mounted cabinet IP55 12U	1 Pc
KWI16600		16U	600x600	Wall-mounted cabinet IP55 16U	1 Pc
KWI18600		18U	600x600	Wall-mounted cabinet IP55 18U	1 Pc
KWI20600		20U	600x600	Wall-mounted cabinet IP55 20U	1 Pc
KWI22600		22U	600x600	Wall-mounted cabinet IP55 22U	1 Pc

KFANxV

Fans unit with analog thermostat



UNIK

- Dual fan system for optimized airflow
- Built-in thermostat for automatic cooling regulation
- Compatible with Start and grid series
- Robust 1 mm steel construction with powder coating

PURCHASE INFO

Item	Item Code	Designation	Packaging
KFAN2V		2-fans module with analog thermostat control	1 Pc
KFAN4V		4-fans module with analog thermostat control	1 Pc

KCHxxxx

Adjustable chairs for START & GRID racks, height 158-280 /



UNIK

- Maximum strength thanks to 2 mm steel structure
- High adaptability in size (600, 800, and 1000 mm) and height (158 up to 520 mm)
- Quick and intuitive installation.

PURCHASE INFO

Item	Item Code	Height (mm)	Dimensions (mm)	Designation	Packaging
KCH881628	U1601003	158-280	800x800	Adjustable chairs for free standing racks 800x800, height from 158mm to 280mm	1 Pc
KCH882852	U1601004	278-520	800x800	Adjustable chairs for free standing racks 800x800, height from 278mm to 520mm	1 Pc
KCH8101628	U1601002	158-280	800x1000	Adjustable chairs for free standing racks 800x1000, height from 158mm to 280mm	1 Pc
KCH8102852	U1601005	278-520	800x1000	Adjustable chairs for free standing racks 800x1000, height from 278mm to 520mm	1 Pc
KCH661628	U1601006	158-280	600x600	Adjustable chairs for free standing racks 600x600, height from 158mm to 280mm	1 Pc
KCH662852	U1601007	278-520	600x600	Adjustable chairs for free standing racks 600x600, height from 278mm to 520mm	1 Pc
KCH681628		158-280	600x800	Adjustable chairs for free standing racks 600x800, height from 158mm to 280mm	1 Pc
KCH682852		278-520	600x800	Adjustable chairs for free standing racks 600x800, height from 278mm to 520mm	1 Pc
KCH6101628		158-280	600x1000	Adjustable chairs for free standing racks 600x1000, height from 158mm to 280mm	1 Pc
KCH68102852		278-520	600x1000	Adjustable chairs for free standing racks 600x1000, height from 278mm to 520mm	1 Pc

KPLINTxx

Plint for START & GRID racks, 100mm height



UNIK

- Heavy-duty steel construction for enhanced stability
- Integrated cable entry for clean routing
- Raised 100mm design for improved air-flow
- Compatible with W600 and W800 cabinets

PURCHASE INFO

Item	Item Code	Height (mm)	Dimensions (mm)	Designation	Packaging
KPLINT66		100	600x600	Plinth 600x600, height 100mm	1 Pc
KPLINT68		100	600x800	Plinth 600x800, height 100mm	1 Pc
KPLINT86		100	800x600	Plinth 800x600, height 100mm	1 Pc
KPLINT88		100	800x800	Plinth 800x800, height 100mm	1 Pc
KPLINT610		100	600x1000	Plinth 600x1000, height 100mm	1 Pc
KPLINT810		100	800x1000	Plinth 800x1000, height 100mm	1 Pc
KPLINT812		100	800x1200	Plinth 800x1200, height 100mm	1 Pc

KGRND

Earthing kit for free standing cabinet and racks



UNIK

- Reliable grounding for enhanced electrical safety
- Multiple connection points for flexible bonding
- Easy installation within 19" cabinets
- Durable copper bar with robust insulation supports

PURCHASE INFO

Item	Item Code	Designation	Packaging
KGRND		Earthing kit for free standing cabinet and racks	Eco-box of 1p

KCASTER4

Caster kit for free-standing cabinets



UNIK

- Heavy-duty caster set supporting full cabinet weight
- 2 lockable casters for secure positioning

PURCHASE INFO

Item	Item Code	Designation	Packaging
KCASTER4	U1201013	Caster kit for free-standing cabinets (4 pcs, 2 with brakes)	Eco-box of 1p

KSFSxU250

19 inches 1U/2U fixed shelf, 250 mm depth



UNIK

- Heavy-duty 1.2 mm steel construction for enhanced stability
- Ideal for non-rackable equipment installation
- Universal compatibility with 19" cabinets
- Quick and easy installation

PURCHASE INFO

Item	Item Code	Designation	Packaging
KSFS1U250	U1201003	19" 1U fixed shelf, 250 mm depth	Eco-box of 1p
KSFS2U250	U1201004	19" 2U fixed shelf, 250 mm depth	Eco-box of 1p

KTRAYxxMM

19 inches 1U fixed shelf, 400mm to 800mm depth



UNIK

- Heavy-duty 1.2 mm steel construction
- Ventilated design for improved airflow
- Adjustable mounting depth for flexible installation

350/450 depth are compatible with D600
 550 depth is compatible with D800
 800 depth is compatible with D1000

PURCHASE INFO

Item	Item Code	Designation	Packaging
KTRAY400MM		19" 1U fixed shelf, 400 mm depth	Eco-box of 1p
KTRAY450MM		19" 1U fixed shelf, 450 mm depth	Eco-box of 1p
KTRAY550MM		19" 1U fixed shelf, 550 mm depth	Eco-box of 1p
KTRAY800MM		19" 1U fixed shelf, 800 mm depth	Eco-box of 1p

KTRAYSLIDxxxMM

19 inches 1U sliding shelf, 350mm to 720mm depth



✓ UNIK

- Sliding rails for easy access to equipment
- Ideal for maintenance and frequent handling
- Ventilated design for improved airflow

350 depth is compatible with D600
 550 depth is compatible with D800
 720 depth is compatible with D1000

● PURCHASE INFO

Item	Item Code	Designation	Packaging
KTRAYSLID350MM		19" 1U sliding shelf, 350 mm depth	Eco-box of 1p
KTRAYSLID550MM		19" 1U sliding shelf, 550 mm depth	Eco-box of 1p
KTRAYSLID720MM		19" 1U sliding shelf, 720 mm depth	Eco-box of 1p

KSBRUSHCEF

19 inches cable management 1U with brush



UNIK

- Facilitate routing for cable
- Direct and optimize airflow of cabinets
- Screws and cage nuts included

PURCHASE INFO

Item	Item Code	Designation	Packaging
KSBRUSHCEF	U1201001	19inch cable management 1U with brush	Eco-box of 1p

KSPFK1U4RCFEF

19 inches cable management 1U with 4 rings full metal



✓ UNIK

- Facilitate routing for cables
- Rings of 64mm depth for high density patching
- Screws and cage nuts included

● PURCHASE INFO

Item	Item Code	Designation	Packaging
KSPFK1U4RCFEF	U1201007	19 inches cable management 1U with 4 rings full metal	Eco-box of 1p

KSPFK1U4RCEF

19-inch 1U perforated cable management panel with 4 rings



UNIK

- Facilitates cable organization within the rack
- 65 mm deep rings for high-density patching
- Includes screws and cage nuts

PURCHASE INFO

Item	Item Code	Designation	Packaging
KSPFK1U4RCEF	U1201006	19-inch 1U perforated cable management panel with 4 rings	Eco-box of 1p

KSPFKxUHDCEF



19-inch 1U/2U high density cable management panel with 4 rings and cover



✓ UNIK

- High-density cable management design
- Removable cover for quick access
- 19" rack-mount compatible
- Black powder-coated steel construction
- Includes screws and cage nuts

● PURCHASE INFO

Item	Item Code	Designation	Packaging
KSPFK1UHDCEF	U1201011	19-inch 1U high density cable management panel with 4 rings	Eco-box of 1p
KSPFK2UHDCEF	U1201018	19-inch 2U high density cable management panel with 4 rings	Eco-box of 1p

KBLANKxU

19 inches 1U/2U/3U/5U blank module

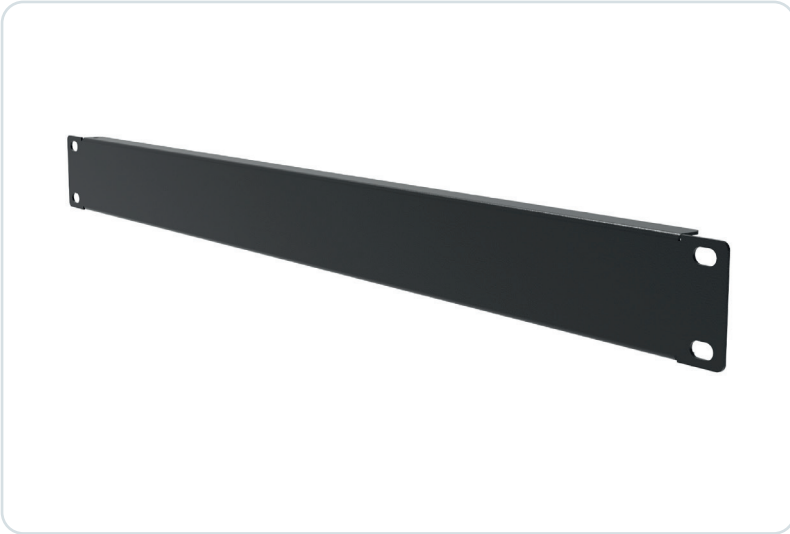

UNIK

- Clean and professional rack appearance
- Improves airflow management and cooling efficiency
- Prevents dust ingress and unauthorized access
- Available in 1U / 2U / 3U / 5U formats

PURCHASE INFO

Item	Item Code	Designation	Packaging
KBLANK1U		19-inch 1U blank module	Eco-box of 1p
KBLANK2U		19-inch 2U blank module	Eco-box of 1p
KBLANK3U		19-inch 3U blank module	Eco-box of 1p
KBLANK5U		19-inch 5U blank module	Eco-box of 1p

KPDUxPC90

Adjustable 1U Power Distribution Unit



✓ UNIK

- 2P+T sockets compliant with NFC15100
- Delivered with adjustable mounting brackets
- Screws and cage nuts included

● PURCHASE INFO

Item	Item Code	Designation	Packaging
KPDU8PC90	U1301002	19" Aluminum Power Strip with 8 Outlets, Adjustable Mounting, and Indicator Light	Eco-box of 1p
KPDU8PCSW90	U1301003	19" Aluminum Power Strip with 8 Outlets, Adjustable Mounting, and Illuminated Switch with Cover	Eco-box of 1p

COPPER

DATA CABLES	72
KEYSTONE JACK & ACCESSORIES	100
PATCH PANEL	118
FACE PLATES	124
PATCH CORDS	130

KCSF84PZHB2

Cat8 cable S/FTP LSZH B2ca 4 pairs, AWG22

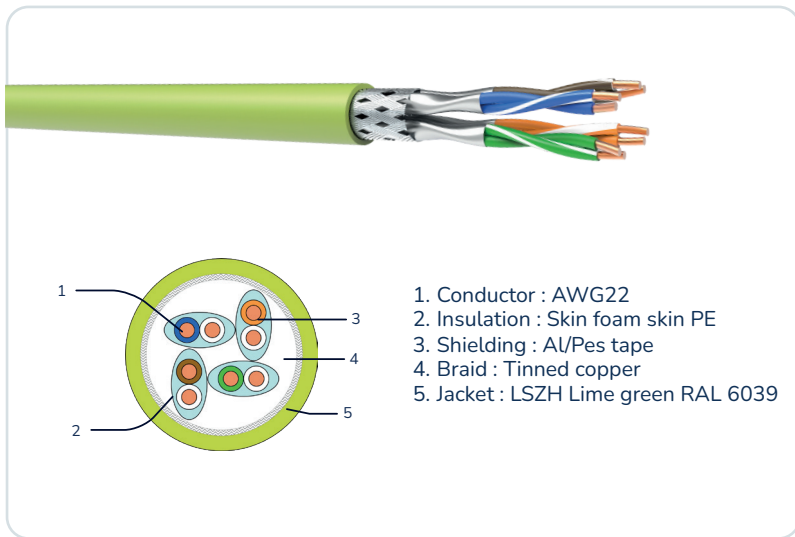

- 1. Conductor : AWG22
- 2. Insulation : Skin foam skin PE
- 3. Shielding : Al/Pes tape
- 4. Braid : Tinned copper
- 5. Jacket : LSZH Lime green RAL 6039

UNIK

- Compliant with ISO 11801 Ed3 Class II
- LSZH jacket B2ca (s1a, d0, a1) EN 50575
- Tested up to 2GHz

COMPLIANCE

Cable

IEC 61156-9 Cat8.2
IEC 60332-1
IEC 60332-3

System

ISO/IEC 11801-1/Amd1:2025 Class II
TIA568.2-E Cat8

Applications

IEEE 802.3 bq 25G BASE T & 40G Base T
IEEE 802.3 af/at/bt PoE : Type 1 to 4, up to 90w

PURCHASE INFO

Item	Item Code	Designation	Diameter (nom)	Weight (Kg/Km)	Packaging
KCSF84PZHB2LI5	U0106001	Cat8 cable 4 pairs S/FTP awg22 LSZH B2ca lime green	8.5mm	64	D500M

KCSF7AxPBZHC

Cat7a cable S/FTP LSZH Cca 4 pairs, AWG22



FIBER

RACKS & ACCESSORIES

COPPER

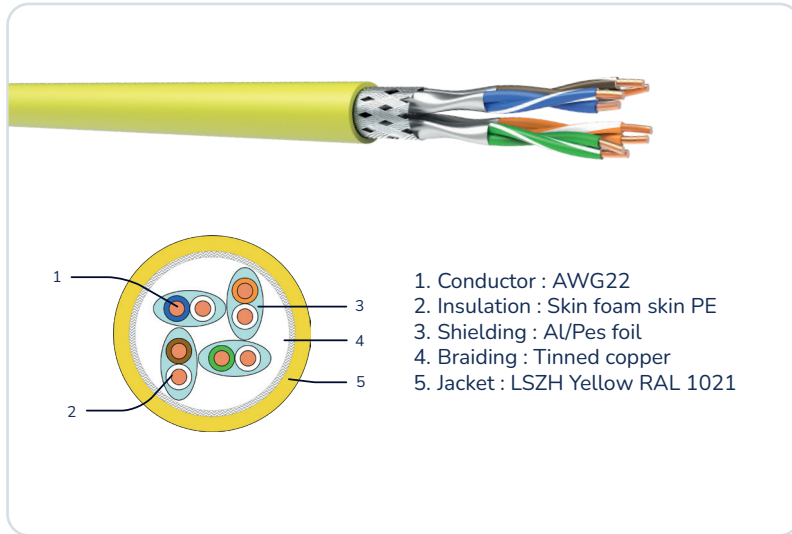

- 1. Conductor : AWG22
- 2. Insulation : Skin foam skin PE
- 3. Shielding : Al/Pes foil
- 4. Braiding : Tinned copper
- 5. Jacket : LSZH Yellow RAL 1021

UNIK

- Compliant with ISO 11801 Class Fa
- LSZH jacket Cca (s1a, d0, a1) EN 50575
- Tested up to 1.2Ghz

PoE 90w

LSZH

Fixed installation
≥ 8 × Ø OD

Operating temperature
-20°C
+60°C

COMPLIANCE

Cable

- IEC 61156-5:2020 Cat7a
- IEC 60332-1
- IEC 60332-3

System

- ISO/IEC 11801-1/Amd1:2025 Class Fa
- EN 50173-1:2018 Class Fa
- EN 50174-2:2018 Segregation Class D

Applications

- IEEE 802.3 an 10G BASE T
- IEEE 802.3 af/at/bt PoE : Type 1 to 4, up to 90w

PURCHASE INFO

Item	Item Code	Designation	Diameter (nom)	Weight (Kg/Km)	Packaging
KCSF7A4PBZHCE5	U0105001	Cat7a cable 4 pairs S/FTP awg22 LSZH Cca yellow	7.8mm	62	D500M

KCSF7AxPZHB2BR

Cat7a cable S/FTP LSZH B2ca 4 pairs, AWG23

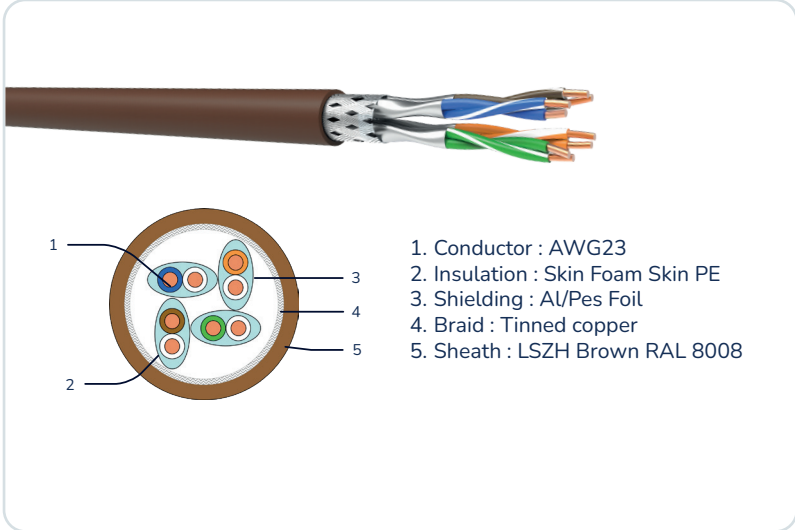

- 1. Conductor : AWG23
- 2. Insulation : Skin Foam Skin PE
- 3. Shielding : Al/Pes Foil
- 4. Braid : Tinned copper
- 5. Sheath : LSZH Brown RAL 8008

UNIK

- Compliant with ISO 11801 Class Fa
- LSZH jacket B2ca (s1a, d0, a1) EN 50575
- Tested up to 1.2GHz

PoE 90w

LSZH

Fixed installation
≥ 8 × Ø OD

Operating temperature
-20°C
+60°C

COMPLIANCE

Cable

- IEC 60156-5:2020 Cat7a
- IEC 60332-1
- IEC 60332-3

System

- ISO/IEC 11801-1/Amd1:2025 Class Fa
- EN 50173-1:2018 Class Fa
- EN 50174-2:2018 Segregation Class D

Applications

- IEEE 802.3 an 10G BASE T
- IEEE 802.3 af/at/bt PoE : Type 1 to 4, up to 90w

PURCHASE INFO

Item	Item Code	Designation	Diameter (nom)	Weight (Kg/Km)	Packaging
KCSF7A4PZHB2BR5	U0105003	Cat7a cable 4 pairs S/FTP awg23 LSZH B2ca brown	7.5mm	59	D500M

KCSF7AxPZHC

Cat7a cable S/FTP LSZH Cca 4 pairs, AWG23



FIBER

RACKS & ACCESSORIES

COPPER

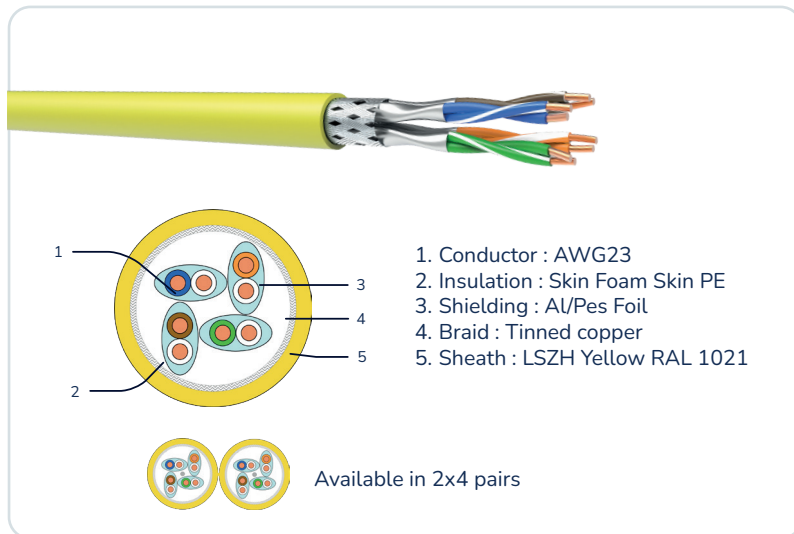

UNIK

- Compliant with ISO 11801 Class Fa
- LSZH jacket Cca (s1a, d0, a1) EN 50575
- Tested up to 1.4GHz

COMPLIANCE

Cable

IEC 60156-5:2020 Cat7a
IEC 60332-1
IEC 60332-3

System

ISO/IEC 11801-1/Amd1:2025 Class Fa
EN 50173-1:2018 Class Fa
EN 50174-2:2018 Segregation Class D

Applications

IEEE 802.3 an 10G BASE T
IEEE 802.3 af/at/bt PoE : Type 1 to 4, up to 90w

PURCHASE INFO

Item	Item Code	Designation	Diameter (nom)	Weight (Kg/Km)	Packaging
KCSF7A4PZHCHYE5	U0105002	Cat7a cable 4 pairs S/FTP awg23 LSZH Cca yellow	7.5mm	59	D500M
KCSF7A8PZHCHYE5	U0105004	Cat7a cable 2x4 pairs S/FTP awg23 LSZH Cca yellow	7.5mmx15.4	121	D500M

KCSF7xPZHC

Cat7 cable S/FTP LSZH Cca 4 pairs & 2x4 pairs, AWG23

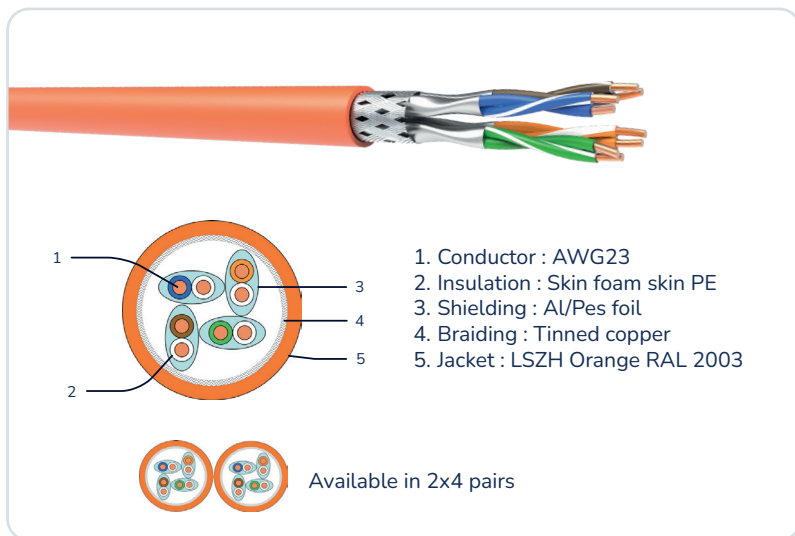

UNIK

- Compliant with ISO 11801 Class F
- Certified by ETL INTERTEK
- LSZH jacket Cca (s1a, d1, a1) EN 50575
- Tested up to 1Ghz



COMPLIANCE

Cable

IEC 61156-5:2020 Cat7
IEC 60332-1
IEC 60332-3

System

ISO/IEC 11801-1/Amd1:2025 Class F
EN 50173-1:2018 Class F
EN 50174-2:2018 Segregation Class D

Applications

IEEE 802.3 an 10G BASE T
IEEE 802.3 af/at/bt PoE : Type 1 to 4, up to 90w

PURCHASE INFO

Item	Item Code	Designation	Diameter (nom)	Weight (Kg/Km)	Packaging
KCSF74PZHCOR5	U0104004	Cat7 cable 4 pairs S/FTP awg23 LSZH Cca orange	7.2mm	52	D500M
KCSF78PZHCOR5	U0104007	Cat7 cable 2x4 pairs S/FTP awg23 LSZH Cca orange	7.2x15mm	106	D500M

KCSF74PEAOUT

Cat7 cable S/FTP PE SWA (Steel wire armour) outdoor 4 pairs, AWG23



FIBER

RACKS & ACCESSORIES

COPPER

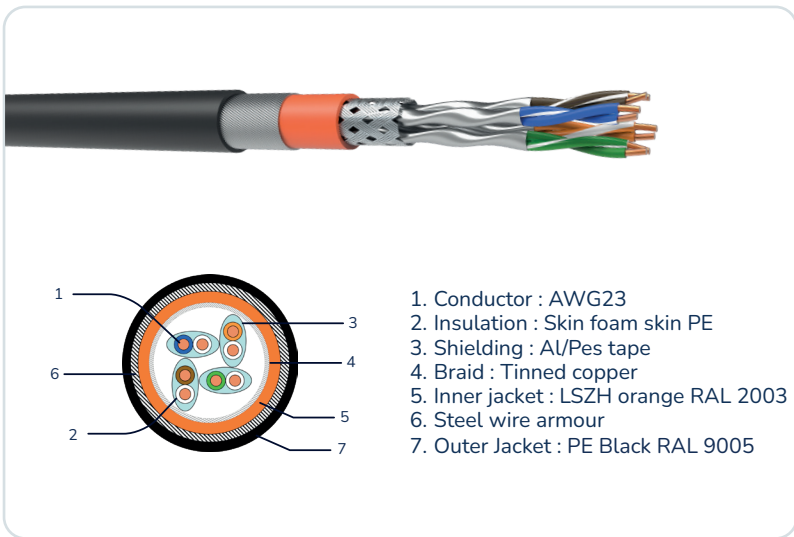

UNIK

- Compliant with ISO 11801 Class F
- Steel wire Armour and PE jacket
- UV resistant, suitable for outdoor and direct buried applications



PoE 90w

PE

Fixed installation $\geq 12 \times \text{Ø OD}$

Operating temperature
-20°C
+60°C

COMPLIANCE

Cable

IEC 61156-5:2020 Cat7

System

ISO/IEC 11801-1/Amd1:2025 Class F
EN 50173-1:2018 Class F

Applications

IEEE 802.3 an 10G BASE T
IEEE 802.3 af/at/bt PoE : Type 1 to 4, up to 90w

PURCHASE INFO

Item	Item Code	Designation	Diameter (nom)	Weight (Kg/Km)	Packaging
KCSF74PEAOUT5	U0104001	Cat7 Cable 4 pairs S/FTP awg23 PE SWA outdoor black	11.5mm	92	D500M

KCSF74PEOUT

Cat7 cable S/FTP PE outdoor 4 Pairs, AWG23

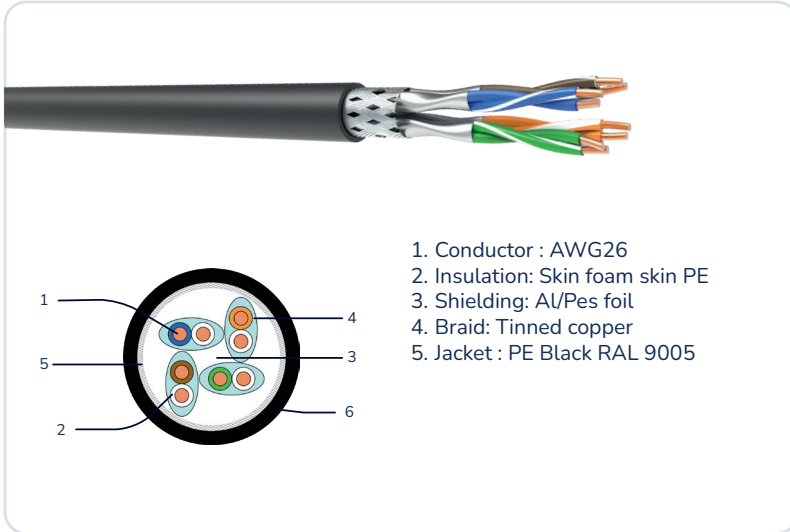

- 1. Conductor : AWG26
- 2. Insulation: Skin foam skin PE
- 3. Shielding: Al/Pes foil
- 4. Braid: Tinned copper
- 5. Jacket : PE Black RAL 9005
- 6. (Label for the outer jacket)

UNIK

- Compliant with ISO 11801 Class F
- PE jacket
- UV resistant, suitable for outdoor applications

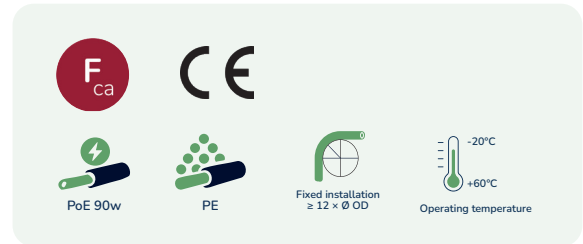

COMPLIANCE

Cable

IEC 61156-5:2020 Cat7

System

ISO/IEC 11801-1/Amd1:2025 Class F
EN 50173-1:2018 Class F

Applications

IEEE 802.3 an 10G BASE T
IEEE 802.3 af/at/bt PoE : Type 1 to 4, up to 90w

PURCHASE INFO

Item	Item Code	Designation	Diameter (nom)	Weight (Kg/Km)	Packaging
KCSF74PEOUT5	U0104002	Cat7 Cable 4 pairs S/FTP awg23 PE outdoor black	7.2mm	52	D500M

KCSF74PLZHOUT

Cat7 cable S/FTP LSZH Dca indoor/outdoor 4 Pairs, AWG26



FIBER

RACKS & ACCESSORIES

COPPER

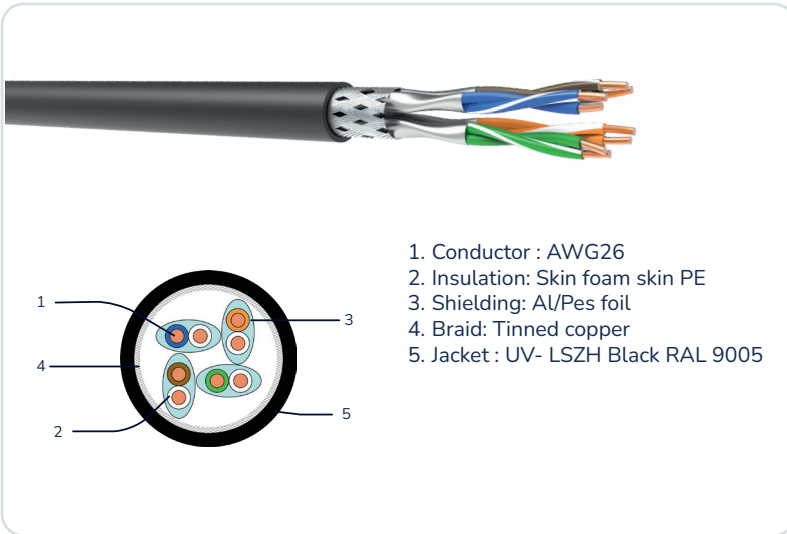

UNIK

- Compliant with ISO 11801 Class Ea up to 60m
- LSZH jacket Dca (s2, d2, a2) EN 50575
- UV resistant, suitable for indoor and outdoor applications



COMPLIANCE

Cable

IEC 61156-6:2020 Cat7
 IEC 60332-1

System

ISO/IEC 11801-1/Amd1:2025 Class Ea
 Up to 60m permanent link

Applications

IEEE 802.3 an 10G BASE T
 IEEE 802.3 af/at PoE : Type 1 & 2, up to 30w

PURCHASE INFO

Item	Item Code	Designation	Diameter (nom)	Weight (Kg/Km)	Packaging
KCSF74PLZHOUT5	U0104002	Cat7 Cable 4 pairs S/FTP awg26 LSZH In/out Dca black	6.0mm	45	D500M

KCSF6AxPZHC

Cat6a cable S/FTP LSZH Cca 4 pairs & 2x4 pairs, AWG23

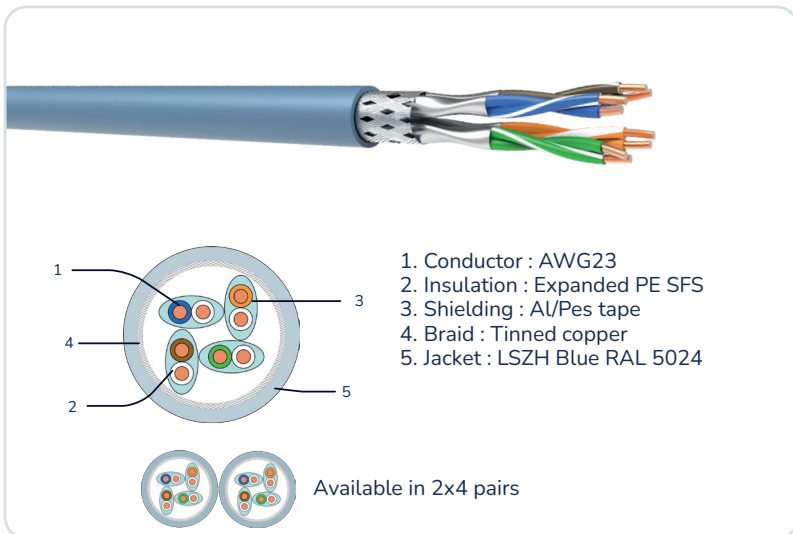

UNIK

- Compliant with ISO 11801 Class Ea
- LSZH jacket Cca (s1a, d1, a1) EN 50575
- Tested up to 650Mhz

COMPLIANCE

Cable

IEC 61156-5:2020 Cat6a
IEC 60332-1
IEC 60332-3

System

ISO/IEC 11801-1/Amd1:2025 Class Ea
EN 50173-1:2018 Class Ea
TIA 568.2-E Cat6a

Applications

IEEE 802.3 an 10G BASE T
IEEE 802.3 af/at/bt PoE Type 1 to 4, up to 90w

PURCHASE INFO

Item	Item Code	Designation	Diameter (nom)	Weight (Kg/Km)	Packaging
KCSF6A4PZHCBL5	U0103008	Cat6a cable 4 pairs S/FTP awg23 LSZH Cca blue	7.4mm	55	D500M
KCSF6A8PZHCBL5	U0103021	Cat6a cable 2x4 pairs S/FTP awg23 LSZH Cca blue	7.4x15mm	112	D500M

KCSF6AxPZHMCB2

Cat6a cable S/FTP LSZH B2ca 4 pairs PH180



FIBER

RACKS & ACCESSORIES

COPPER

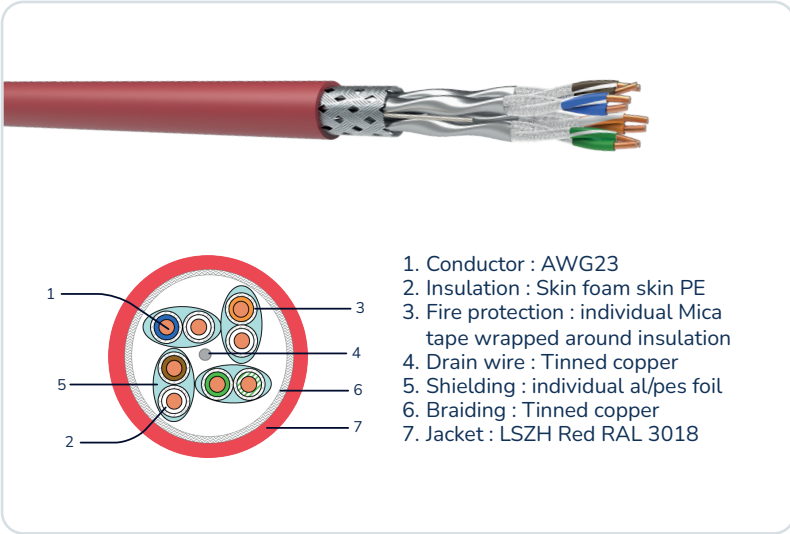

1. Conductor : AWG23
2. Insulation : Skin foam skin PE
3. Fire protection : individual Mica tape wrapped around insulation
4. Drain wire : Tinned copper
5. Shielding : individual al/pes foil
6. Braiding : Tinned copper
7. Jacket : LSZH Red RAL 3018

UNIK

- Compliant to ISO 11801 Class Ea
- LSZH jacket B2ca (s1a, d0, a1) EN 50575
- Fire resistance IEC 60331-23:20(PH180)
- UV & Excellent fire properties



COMPLIANCE

Cable

IEC 61156-5:2020 Cat6a
IEC 60331-23:1999 PH180
IEC 60332-3

System

ISO/IEC 11801-1/Amd1:2025 Class Ea
EN 50173-1:2018 Class Ea
TIA 568.2-E Cat6a

Applications

IEEE 802.3 an 10G BASE T
IEEE 802.3 af/at/bt PoE Type 1 to 4, up to 90w

PURCHASE INFO

Item	Item Code	Designation	Diameter (nom)	Weight (Kg/Km)	Packaging
KCSF6A4PZHMCB2	U0103024	Cat6a cable S/FTP LSZH B2ca 4 pairs PH180 red	8.8mm	59	D500M

KCFF6A x PZHB2

Cat6a cable F/FTP LSZH B2ca 4 pairs, AWG23

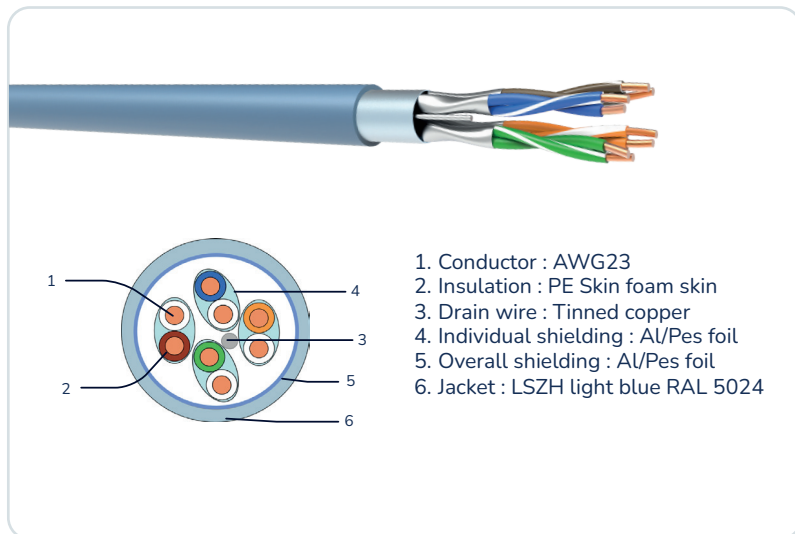

1. Conductor : AWG23
2. Insulation : PE Skin foam skin
3. Drain wire : Tinned copper
4. Individual shielding : Al/Pes foil
5. Overall shielding : Al/Pes foil
6. Jacket : LSZH light blue RAL 5024

UNIK

- Compliant with ISO 11801 Class Ea
- Certified by ETL INTERTEK
- LSZH jacket B2ca (s1a, d0, a1) EN 50575
- Tested up to 650Mhz

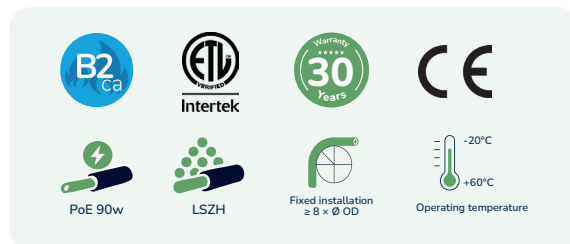

COMPLIANCE

Cable

- IEC 61156-5:2020 Cat6a
- IEC 60332-1
- IEC 60332-3

System

- ISO/IEC 11801-1/Amd1:2025 Class Ea
- EN 50173-1:2018 Class Ea
- TIA 568.2-E Cat6a

Applications

- IEEE 802.3 an 10G BASE T
- IEEE 802.3 af/at/bt PoE Type 1 to 4, up to 90w

PURCHASE INFO

Item	Item Code	Designation	Diameter (nom)	Weight (Kg/Km)	Packaging
KCFF6A4PZHB2BL5	U0103002	Cat6a Cable 4 pairs F/FTP awg23 LSZH B2ca blue	7.2mm	52	D500M

KCFF6AxPZHC

Cat6a cable F/FTP LSZH Cca 4 pairs & 2x4 pairs, AWG23



FIBER

RACKS & ACCESSORIES

COPPER

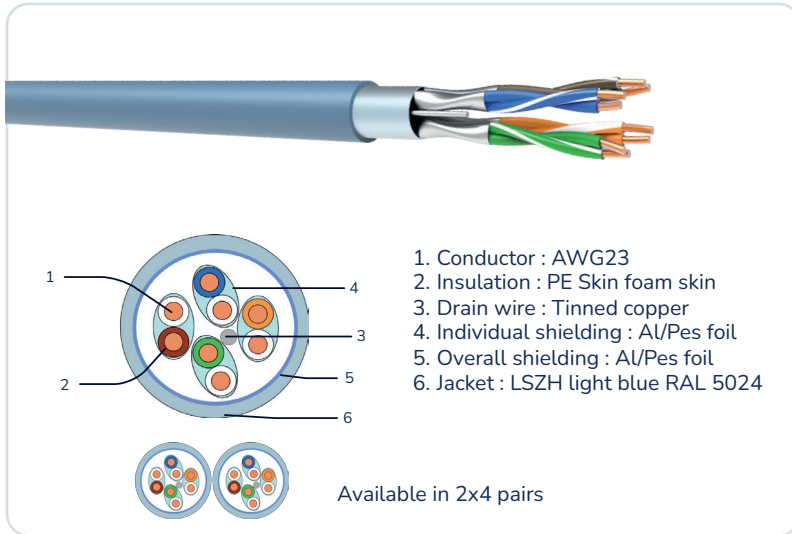

UNIK

- Compliant with ISO 11801 Class Ea
- Certified by ETL INTERTEK
- LSZH jacket Cca (s1a, d1, a1) EN 50755
- Tested up to 650Mhz



COMPLIANCE

Cable

- IEC 61156-5:2020 Cat6a
- IEC 60332-1
- IEC 60332-3

System

- ISO/IEC 11801-1/Amd1:2025 Class Ea
- EN 50173-1:2018 Class Ea
- TIA 568.2-E Cat6a

Applications

- IEEE 802.3 an 10G BASE T
- IEEE 802.3 af/at/bt PoE Type 1 to 4, up to 90w

PURCHASE INFO

Item	Item Code	Designation	Diameter (nom)	Weight (Kg/Km)	Packaging
KCFF6A4PZHCBLS	U0103003	Cat6a Cable 4 pairs F/FTP awg23 LSZH Cca blue	7.2mm	51	D500M
KCFF6A4PZHCBLS	U0103019	Cat6a Cable 4 pairs F/FTP awg23 LSZH Cca blue	7.2mm	51	B305M
KCFF6A8PZHCBLS	U0103020	Cat6a Cable 2x4 pairs F/FTP awg23 LSZH Cca blue	7.2x15mm	102	D500M

KCFF6AxPZH D

Cat6a cable F/FTP LSZH Dca 4 pairs & 2x4 pairs, AWG23

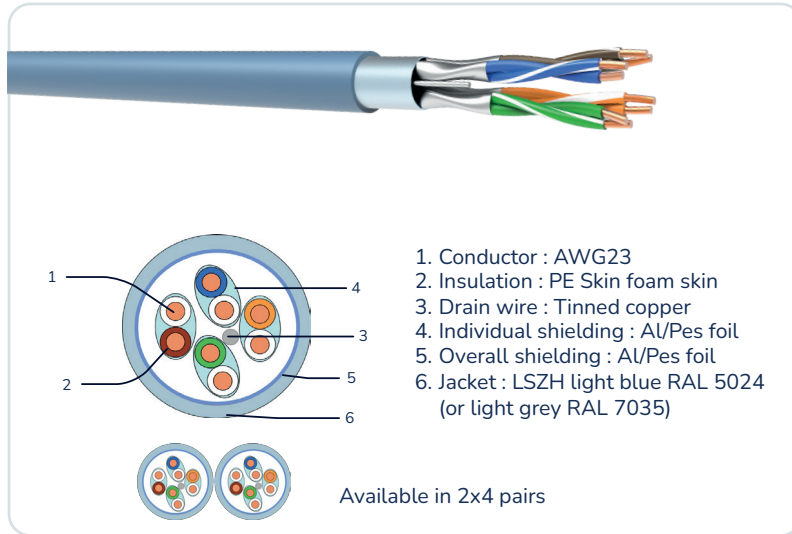

Available in 2x4 pairs

UNIK

- Compliant with ISO 11801 Class Ea
- Certified by ETL INTERTEK
- LSZH jacket Dca (s2, d1, a1) EN 50575
- Tested up to 650Mhz



COMPLIANCE

Cable

IEC 61156-5:2020 Cat6a
IEC 60332-1

System

ISO/IEC 11801-1/Amd1:2025 Class Ea
EN 50173-1:2018 Class Ea
TIA 568.2-E Cat6a

Applications

IEEE 802.3 an 10G BASE T
IEEE 802.3 af/at/bt PoE Type 1 to 4, up to 90w

PURCHASE INFO

Item	Item Code	Designation	Diameter (nom)	Weight (Kg/Km)	Packaging
KCFF6A4PZHDBL5	U0103001	Cat6a Cable 4 pairs F/FTP awg23 LSZH Dca blue	7.0mm	50	D500M
KCFF6A4PZHDBLB	U010306	Cat6a Cable 4 pairs F/FTP awg23 LSZH Dca blue	7.0mm	50	B305M
KCFF6A8PZHDBL5	U0103007	Cat6a Cable 2x4 pairs F/FTP awg23 LSZH Dca blue	7.0x14.8mm	102	D500M
KCFF6A4PZH DGR5	U0103016	Cat6a Cable 4 pairs F/FTP awg23 LSZH Dca grey	7.0mm	50	D500M
KCFF6A8PZH DGR5	U0103017	Cat6a Cable 2x4 pairs F/FTP awg23 LSZH Dca grey	7.0x14.8mm	102	D500M

KCUF6AxPZHCOU

Cat6a cable U/FTP LSZH Cca indoor/outdoor 4 pairs, AWG23



FIBER

RACKS & ACCESSORIES

COPPER

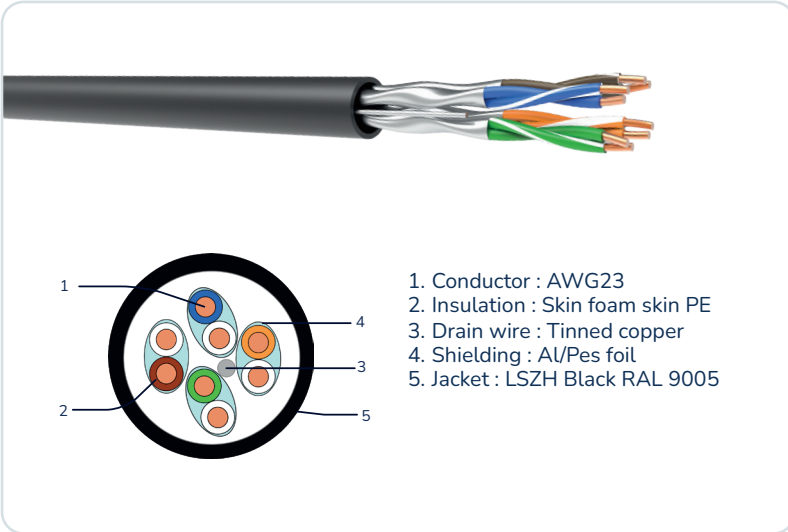

UNIK

- Compliant with ISO 11801 Class Ea
- LSZH jacket Cca (s1a, d1, a1) EN 50575
- Tested up to 650Mhz

COMPLIANCE

Cable

IEC 61156-5:2020 Cat6a
IEC 60332-1
IEC 60332-3

System

ISO/IEC 11801-1/Amd1:2025 Class Ea
EN 50173-1:2018 Class Ea
TIA 568.2-E Cat6a

Applications

IEEE 802.3 an 10G BASE T
IEEE 802.3 af/at/bt PoE Type 1 to 4, up to 90w

PURCHASE INFO

Item	Item Code	Designation	Diameter (nom)	Weight (Kg/Km)	Packaging
KCUF6A4PZHCOU5	U0103026	Cat6a cable 4 pairs U/FTP awg23 LSZH Cca Indoor/Outdoor black	7.5mm	50	D500M

KCFU6AxPZHC

Cat6a cable F/UTP LSZH Cca 4 pairs, AWG23

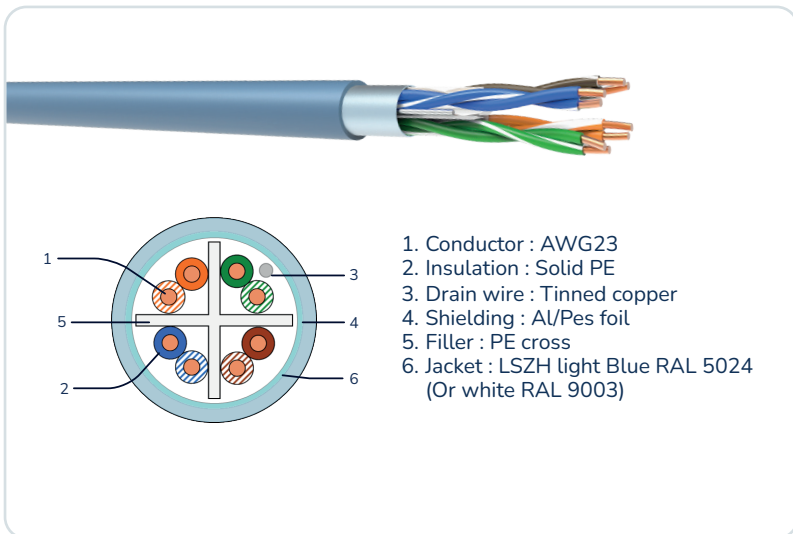

1. Conductor : AWG23
2. Insulation : Solid PE
3. Drain wire : Tinned copper
4. Shielding : Al/Pes foil
5. Filler : PE cross
6. Jacket : LSZH light Blue RAL 5024 (Or white RAL 9003)

UNIK

- Compliant with ISO 11801 Class Ea
- Certified by ETL INTERTEK
- LSZH jacket Cca (s1, d1, a1) EN 50575
- Tested up to 650Mhz

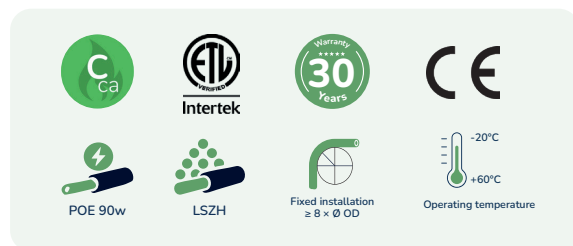

COMPLIANCE

Cable

IEC 61156-5:2020 Cat6a
IEC 60332-1
IEC 60332-3

System

ISO/IEC 11801-1/Amd1:2025 Class Ea
EN 50173-1:2018 Class Ea
TIA 568.2-E Cat6a

Applications

IEEE 802.3 an 10G BASE T
IEEE 802.3 af/at/bt PoE Type 1 to 4, up to 90w

PURCHASE INFO

Item	Item Code	Designation	Diameter (nom)	Weight (Kg/Km)	Packaging
KCFU6A4PZHCBL5		Cat6a cable 4 pairs F/UTP awg23 LSZH Cca blue	6.8mm	49	D500M
KCFU6A4PZHCWH5		Cat6a cable 4 pairs F/UTP awg23 LSZH Cca white	6.8mm	49	D500M

KCFU6AxPZHD

Cat6a cable F/UTP LSZH Dca 4 pairs & 2x4 pairs, AWG23



FIBER

RACKS & ACCESSORIES

COPPER

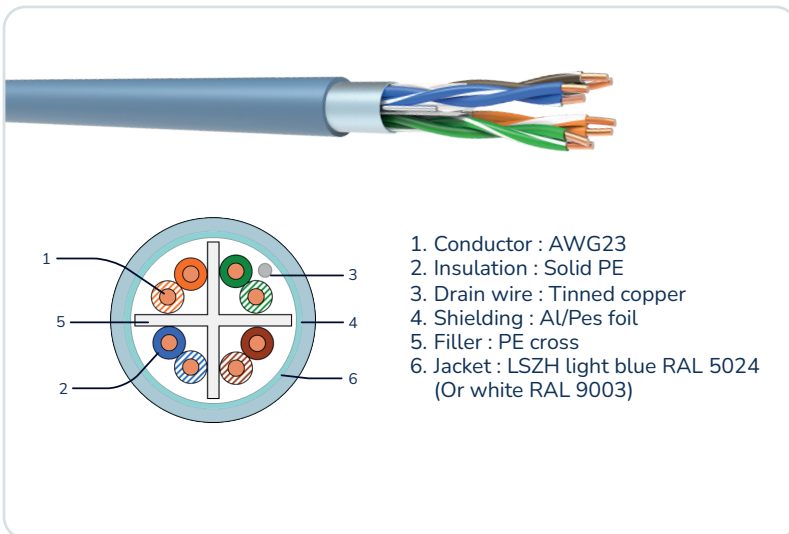

1. Conductor : AWG23
2. Insulation : Solid PE
3. Drain wire : Tinned copper
4. Shielding : Al/Pes foil
5. Filler : PE cross
6. Jacket : LSZH light blue RAL 5024 (Or white RAL 9003)

UNIK

- Compliant with ISO 11801 Class Ea
- Certified by ETL INTERTEK
- LSZH jacket Dca (s2, d2, a2) EN 50575
- Tested up to 650Mhz



COMPLIANCE

Cable

IEC 61156-5:2020 Cat6a
IEC 60332-1

System

ISO/IEC 11801-1/Amd1:2025 Class Ea
EN 50173-1:2018 Class Ea
TIA 568.2-E Cat6a

Applications

IEEE 802.3 an 10G BASE T
IEEE 802.3 af/at/bt PoE Type 1 to 4, up to 90w

PURCHASE INFO

Item	Item Code	Designation	Diameter (nom)	Weight (Kg/Km)	Packaging
KCFU6A4PZHDBL5		Cat6a cable 4 pairs F/UTP awg23 LSZH Dca blue	6.6mm	48	D500M
KCFU6A4PZHDBLB		Cat6a cable 4 pairs F/UTP awg23 LSZH Dca blue	6.6mm	48	B305M
KCFU6A8PZHDBL5		Cat6a cable 2x4 pairs F/UTP awg23 LSZH Dca blue	6.6x14.8mm	98	D500M
KCFU6A4PZHDPWH5	U0103018	Cat6a cable 4 pairs F/UTP awg23 LSZH Dca white	6.6mm	48	D500M
KCFU6A8PZHDPWH5		Cat6a cable 2x4 pairs F/UTP awg23 LSZH Dca white	6.6x14.8mm	98	D500M

KCU6AxPZHc

Cat6a cable U/UTP Encapsulated LSZH Cca 4 pairs, AWG23

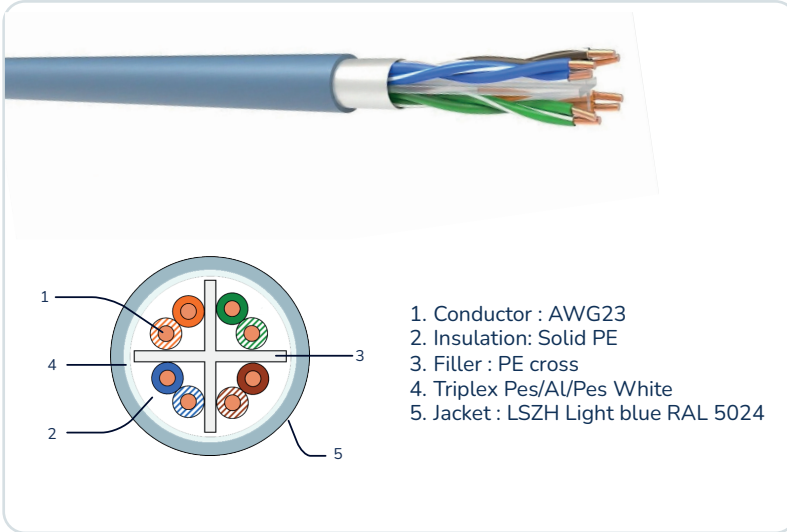

- 1. Conductor : AWG23
- 2. Insulation: Solid PE
- 3. Filler : PE cross
- 4. Triplex Pes/Al/Pes White
- 5. Jacket : LSZH Light blue RAL 5024

UNIK

- Compliant with ISO 11801 Class Ea
- Unique Triplex EMI Barrier (Pes/Al/Pes)
- Certified ANEXT by DELTA FORCE
- LSZH jacket Cca (s1a, d1, a1) EN 50575
Tested up to 650Mhz



COMPLIANCE

Cable

IEC 61156-5:2020 Cat6a
IEC 60332-1
IEC 60332-3

System

ISO/IEC 11801-1/Amd1:2025 Class Ea
EN 50173-1:2018 Class Ea
TIA 568.2-E Cat6a

Applications

IEEE 802.3 an 10G BASE T
IEEE 802.3 af/at/bt PoE Type 1 to 4, up to 90w

PURCHASE INFO

Item	Item Code	Designation	Diameter (nom)	Weight (Kg/Km)	Packaging
KCU6A4PZHcBL5		Cat6a cable 4 pairs U/UTP Encapsulated awg23 LSZH Cca blue	7.5mm	49	D500M
KCU6A4PZHcBLB		Cat6a cable 4 pairs U/UTP Encapsulated awg23 LSZH Cca blue	7.5mm	49	B305M

KCU6AxPZH D

Cat6a cable U/UTP Encapsulated LSZH Dca 4 pairs, AWG23



FIBER

RACKS & ACCESSORIES

COPPER

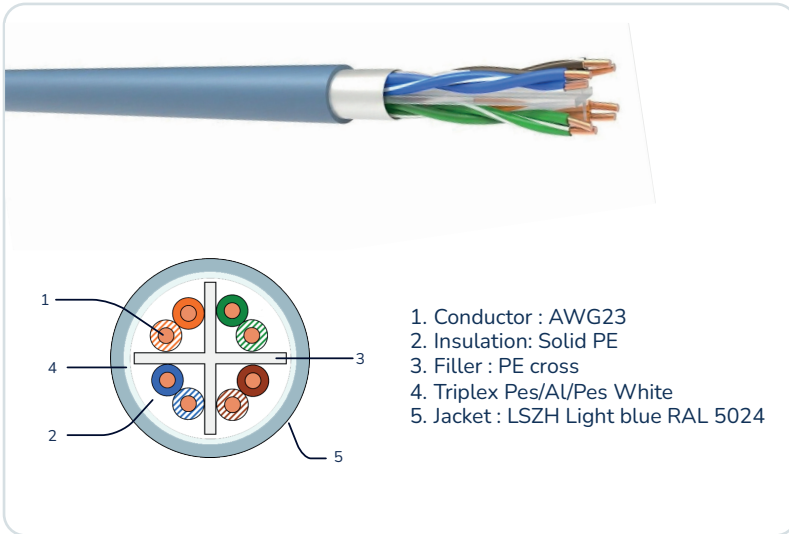

- 1. Conductor : AWG23
- 2. Insulation: Solid PE
- 3. Filler : PE cross
- 4. Triplex Pes/Al/Pes White
- 5. Jacket : LSZH Light blue RAL 5024

UNIK

- Compliant with ISO 11801 Class Ea
- Unique Triplex EMI Barrier (Pes/Al/Pes)
- Certified ANEXT by DELTA FORCE
- LSZH jacket Dca (s2, d1, a1) EN 50575
Tested up to 650Mhz



COMPLIANCE

Cable

IEC 61156-5:2020 Cat6a
IEC 60332-1

System

ISO/IEC 11801-1/Amd1:2025 Class Ea
EN 50173-1:2018 Class Ea
TIA 568.2-E Cat6a

Applications

IEEE 802.3 an 10G BASE T
IEEE 802.3 af/at/bt PoE Type 1 to 4, up to 90w

PURCHASE INFO

Item	Item Code	Designation	Diameter (nom)	Weight (Kg/Km)	Packaging
KCU6A4PZHDBL5	U0103011	Cat6a cable 4 pairs U/UTP Encapsulated awg23 LSZH Dca blue	7.3mm	48	D500M
KCU6A4PZHDBLB		Cat6a cable 4 pairs U/UTP Encapsulated awg23 LSZH Dca blue	7.3mm	48	B305M

KCU6AxPLZHD

Cat6a cable U/UTP LSZH Dca 4 pairs, AWG23

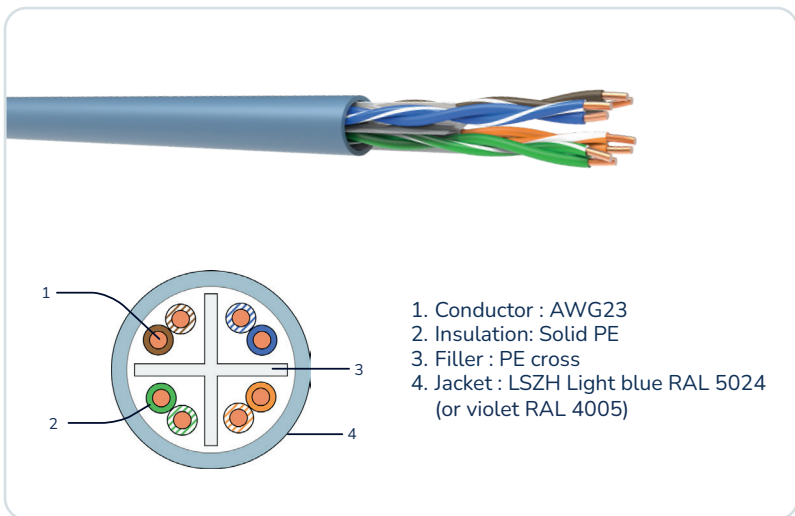

UNIK

- Compliant with ISO 11801 Class Ea
- Certified by ETL INTERTEK
- LSZH jacket Dca (s2, d2, a2) EN 50575
- Tested up to 650Mhz



COMPLIANCE

Cable

IEC 61156-5:2020 Cat6a
 IEC 60332-1

System

ISO/IEC 11801-1/Amd1:2025 Class Ea
 EN 50173-1:2018 Class Ea
 TIA 568.2-E Cat6a

Applications

IEEE 802.3 an 10G BASE T
 IEEE 802.3 af/at/bt PoE Type 1 to 4, up to 90w

PURCHASE INFO

Item	Item Code	Designation	Diameter (nom)	Weight (Kg/Km)	Packaging
KCU6A4PLZHDBL5	U0103010	Cat6a cable 4 pairs U/UTP awg23 LSZH Dca blue	6.3mm	46	D500M
KCU6A4PLZHDBLB		Cat6a cable 4 pairs U/UTP awg23 LSZH Dca blue	6.3mm	46	B305M
KCU6A4PLZHDAV5	U0103025	Cat6a cable 4 pairs U/UTP awg23 LSZH Dca violet	6.3mm	46	D500M
KCU6A4PLZHDAVIB	U0103010	Cat6a cable 4 pairs U/UTP awg23 LSZH Dca violet	6.3mm	46	B305M

KCFU6xPZHD

Cat6 cable F/UTP LSZH Dca 4 pairs & 2x4 pairs, AWG23



FIBER

RACKS & ACCESSORIES

COPPER

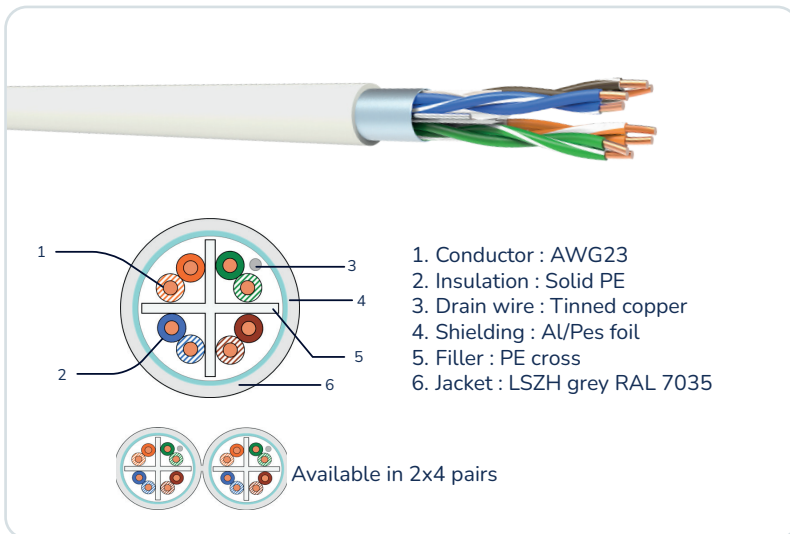

UNIK

- Compliant with ISO 11801 Class E
- Certified by ETL INTERTEK
- LSZH jacket Dca (s2, d2, a2) EN 50575
- Tested up to 400Mhz

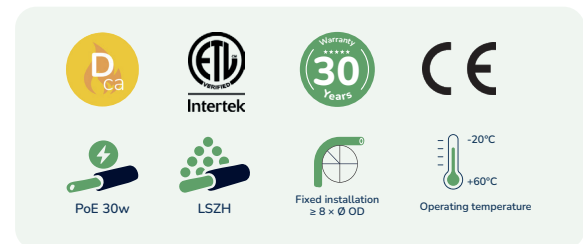

COMPLIANCE

Cable

IEC 61156-5:2020 Cat6
IEC 60332-1

System

ISO/IEC 11801-1/Amd1:2025 Class E
EN 50173-1:2018 Class E
TIA 568.2-E Cat6

Applications

IEEE 802.3 ab/bz 1G, 2.5G & 5G BASE T
IEEE 802.3 af/at PoE Type 1 & 2, up to 30w

PURCHASE INFO

Item	Item Code	Designation	Diameter (nom)	Weight (Kg/Km)	Packaging
KCFU64PZHDGR5	U0102001	Cat6 cable 4 pairs F/UTP awg23 LSZH Dca grey	6.9mm	49	D500M
KCFU64PZHDGRB	U0102002	Cat6 cable 4 pairs F/UTP awg23 LSZH Dca grey	6.9mm	49	B305M
KCFU68PZHDGR5	U0102003	Cat6 cable 2x4 pairs F/UTP awg23 LSZH Dca grey	6.9x14mm	98	D500M

KCFU6xPLZHD

Cat6 cable F/UTP LSZH Dca 4 pairs, AWG24

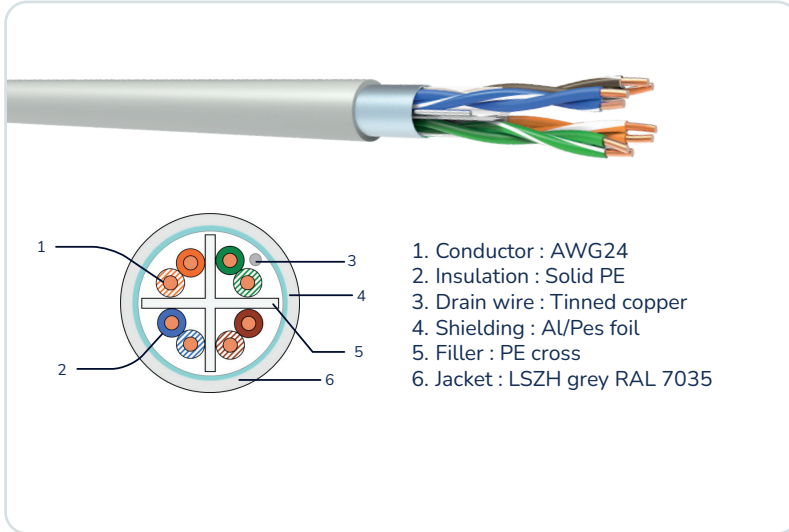

- 1. Conductor : AWG24
- 2. Insulation : Solid PE
- 3. Drain wire : Tinned copper
- 4. Shielding : Al/Pes foil
- 5. Filler : PE cross
- 6. Jacket : LSZH grey RAL 7035

UNIK

- Compliant with ISO 11801 Class E
- Certified by ETL INTERTEK
- LSZH jacket Dca (s2, d2, a2) EN 50575
- Tested up to 250Mhz



COMPLIANCE

Cable

IEC 61156-5:2020 Cat6
IEC 60332-1

System

ISO/IEC 11801-1/Amd1:2025 Class E
EN 50173-1:2018 Class E
TIA 568.2-E Cat6

Applications

IEEE 802.3 ab/bz 1G, 2.5G & 5G BASE T
IEEE 802.3 af/at PoE Type 1 & 2, up to 30w

PURCHASE INFO

Item	Item Code	Designation	Diameter (nom)	Weight (Kg/Km)	Packaging
KCFU64PLZHDGR5		Cat6 cable 4 pairs F/UTP awg24 LSZH Dca grey	6.4mm	46	D500M
KCFU64PLZHDGRB		Cat6 cable 4 pairs F/UTP awg24 LSZH Dca grey	6.4mm	46	B305M

KCU6xPZHB2

Cat6 cable U/UTP LSZH B2ca 4 pairs, AWG23



FIBER

RACKS & ACCESSORIES

COPPER

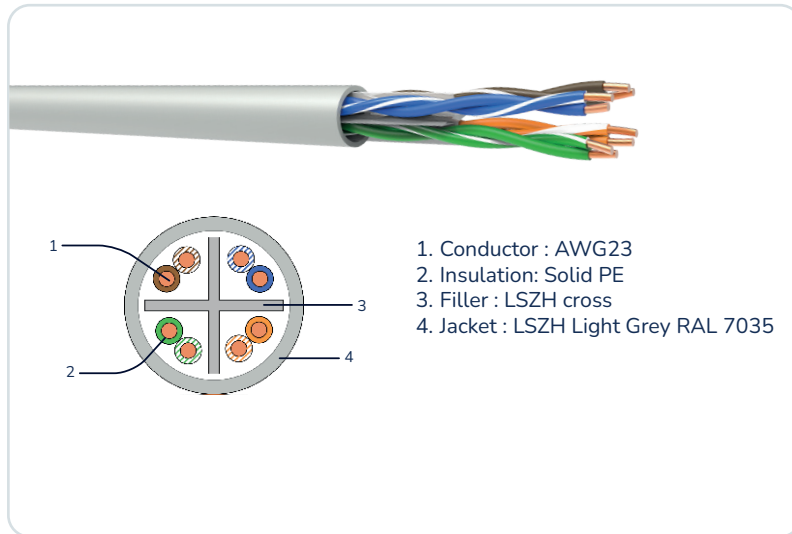

UNIK

- Compliant with ISO 11801 Class E
- SGS Verified for System 1+
- LSZH jacket B2a (s1a, d0, a1) EN 50575
- Tested up to 400Mhz

COMPLIANCE

Cable

IEC 61156-5:2020 Cat6
 IEC 60332-1
 IEC 60332-3

System

ISO/IEC 11801-1/Amd1:2025 Class E
 EN 50173-1:2018 Class E
 TIA 568.2-E Cat6

Applications

IEEE 802.3 ab/bz 1G, 2.5G & 5G BASE T
 IEEE 802.3 af/at PoE Type 1 & 2, up to 30w

PURCHASE INFO

Item	Item Code	Designation	Diameter (nom)	Weight (Kg/Km)	Packaging
KCU64PZHB2GR5		Cat6 cable 4 pairs U/UTP awg23 LSZH B2ca grey	6.0mm	48	D500M

KCU6xPZHC

Cat6 cable U/UTP LSZH Cca 4 pairs, AWG23

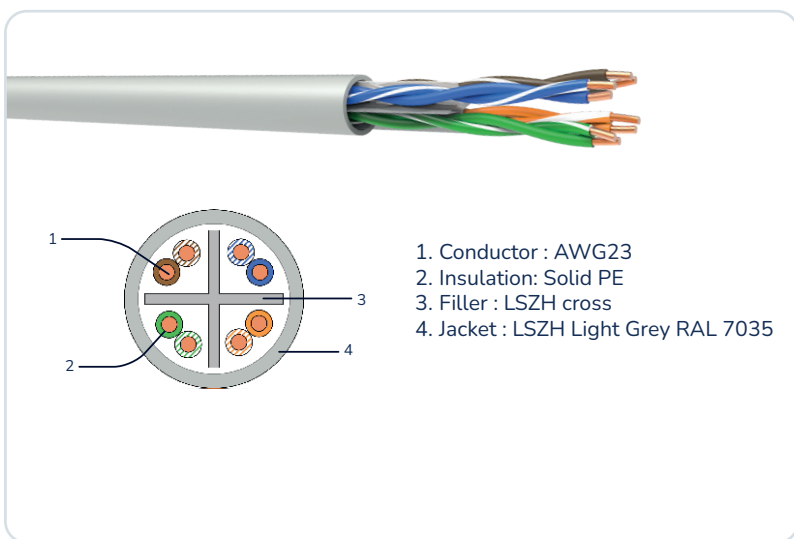

UNIK

- Compliant with ISO 11801 Class E
- SGS Verified for System 1+
- LSZH jacket Cca (s1a, d0, a1) EN 50575
- Tested up to 400Mhz

COMPLIANCE

Cable

IEC 61156-5:2020 Cat6
 IEC 60332-1
 IEC 60332-3

System

ISO/IEC 11801-1/Amd1:2025 Class E
 EN 50173-1:2018 Class E
 TIA 568.2-E Cat6

Applications

IEEE 802.3 ab/bz 1G, 2.5G & 5G BASE T
 IEEE 802.3 af/at PoE Type 1 & 2, up to 30w

PURCHASE INFO

Item	Item Code	Designation	Diameter (nom)	Weight (Kg/Km)	Packaging
KCU64PZHCGR5		Cat6 cable 4 pairs U/UTP awg23 LSZH Cca grey	6.0mm	47	D500M
KCU64PZHCGRB		Cat6 cable 4 pairs U/UTP awg23 LSZH Cca grey	6.0mm	47	B305M

KCU6xPZH D

Cat6 cable U/UTP LSZH Dca 4 pairs, AWG23



FIBER

RACKS & ACCESSORIES

COPPER

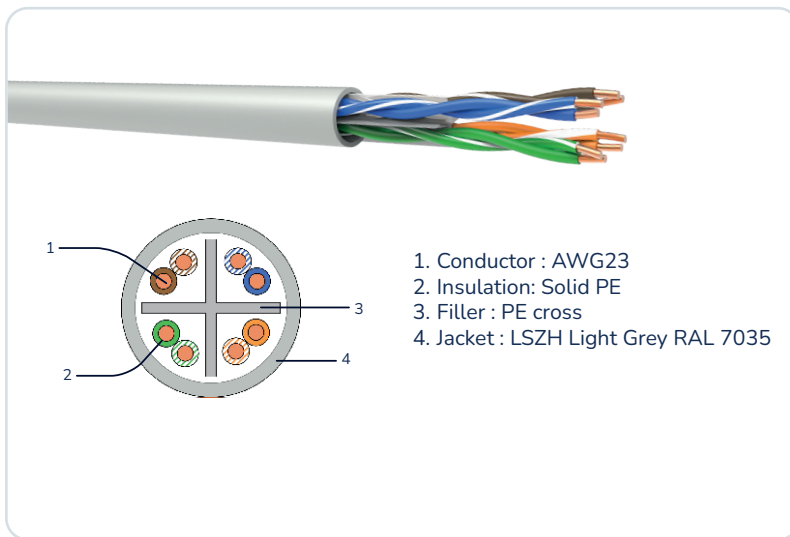

UNIK

- Compliant with ISO 11801 Class E
- Certified by ETL INTERTEK
- LSZH jacket Dca (s2, d2, a2) EN 50575
- Tested up to 400Mhz

COMPLIANCE

Cable

IEC 61156-5:2020 Cat6
 IEC 60332-1

System

ISO/IEC 11801-1/Amd1:2025 Class E
 EN 50173-1:2018 Class E
 TIA 568.2-E Cat6

Applications

IEEE 802.3 ab/bz 1G, 2.5G & 5G BASE T
 IEEE 802.3 af/at PoE Type 1 & 2, up to 30w

PURCHASE INFO

Item	Item Code	Designation	Diameter (nom)	Weight (Kg/Km)	Packaging
KCU64PZH DGR5	U0102008	Cat6 cable 4 pairs U/UTP awg23 LSZH Dca grey	5.8mm	45	D500M
KCU64PZH DGRB	U0102009	Cat6 cable 4 pairs U/UTP awg23 LSZH Dca grey	5.8mm	45	B305M

KCU6xPEOUT

Cat6 cable U/UTP PE outdoor 4 pairs, AWG23

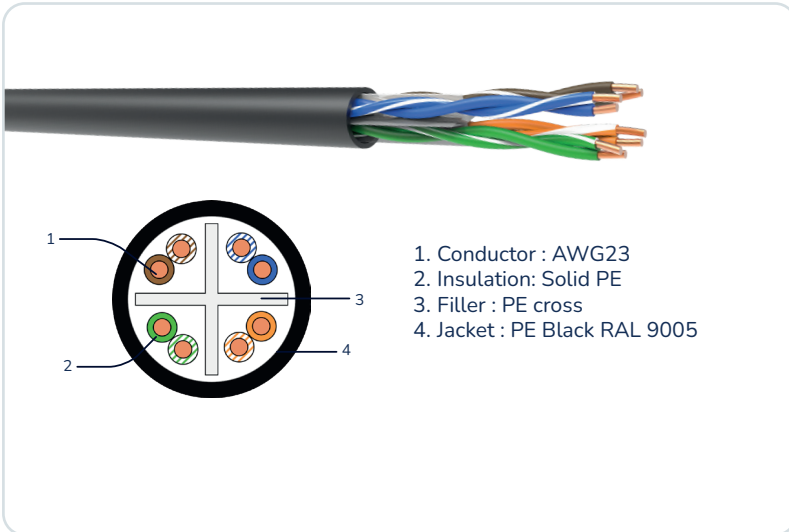

UNIK

- Compliant with ISO 11801 Class E
- PE jacket
- UV resistant, suitable for outdoor applications

COMPLIANCE

Cable

IEC 61156-5:2020 Cat6

System

ISO/IEC 11801-1/Amd1:2025 Class E
 EN 50173-1:2018 Class E
 TIA 568.2-E Cat6

Applications

IEEE 802.3 ab/bz 1G, 2.5G & 5G BASE T
 IEEE 802.3 af/at PoE Type 1 & 2, up to 30w

PURCHASE INFO

Item	Item Code	Designation	Diameter (nom)	Weight (Kg/Km)	Packaging
KCU64PEOUT5	U0102004	Cat6 cable 4 pairs U/UTP awg23 PE Outdoor black	7.5mm	47	D500M

KCU6xP

Cat6 cable U/UTP PVC Eca 4 pairs, AWG23



FIBER

RACKS & ACCESSORIES

COPPER

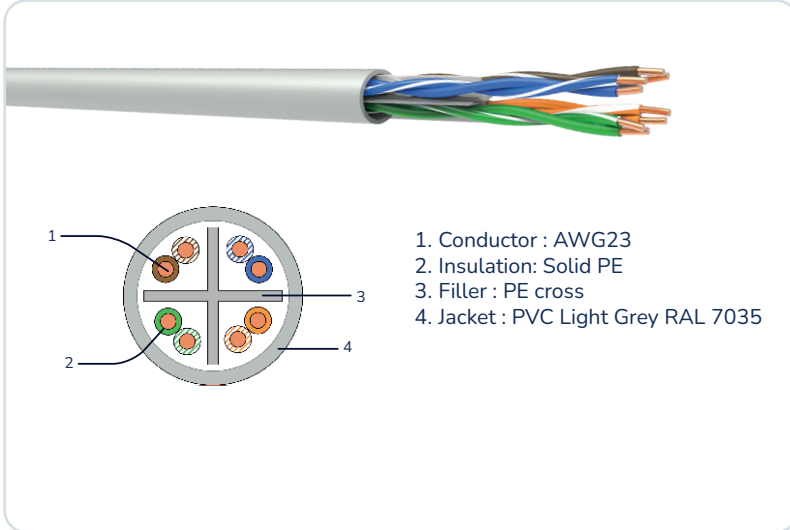

UNIK

- Compliant with ISO 11801 Class E
- PVC jacket Eca EN 50575
- Tested up to 250Mhz

Eca
 30 Year Warranty
 CE
 PoE 30w
 PVC
 Fixed installation $\approx 8 \times \text{Ø OD}$
 Operating temperature: -20°C to +70°C

COMPLIANCE

Cable

IEC 61156-5:2020 Cat6
 IEC 60332-1

System

ISO/IEC 11801-1/Amd1:2025 Class E
 EN 50173-1:2018 Class E
 TIA 568.2-E Cat6

Applications

IEEE 802.3 ab/bz 1G, 2.5G & 5G BASE T
 IEEE 802.3 af/at PoE Type 1 & 2, up to 30w

PURCHASE INFO

Item	Item Code	Designation	Diameter (nom)	Weight (Kg/Km)	Packaging
KCU64PGR5		Cat6 cable 4 pairs U/UTP awg23 PVC Eca grey	5.9mm	44	D500M
KCU64PGRB		Cat6 cable 4 pairs U/UTP awg23 PVC Eca grey	5.9mm	44	B305M

KCU6xPLZHD

Cat6 cable U/UTP LSZH Dca 4 pairs, AWG24

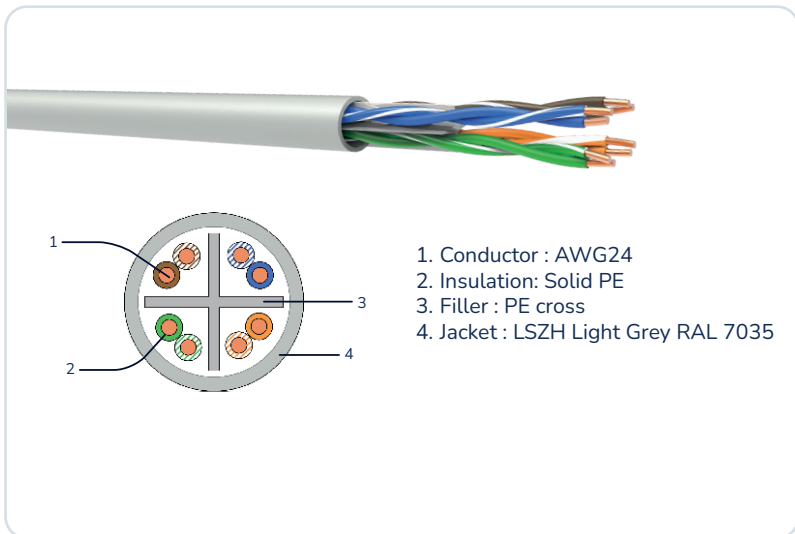

UNIK

- Compliant with ISO 11801 Class E
- Certified by ETL INTERTEK
- LSZH jacket Dca (s2, d2, a2) EN 50575
- Tested up to 250Mhz

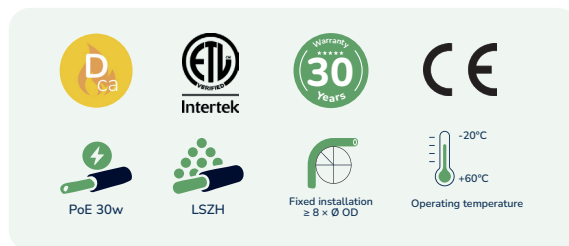

COMPLIANCE

Cable

IEC 61156-5:2020 Cat6
 IEC 60332-1

System

ISO/IEC 11801-1/Amd1:2025 Class E
 EN 50173-1:2018 Class E
 TIA 568.2-E Cat6

Applications

IEEE 802.3 ab/bz 1G, 2.5G & 5G BASE T
 IEEE 802.3 af/at PoE Type 1 & 2, up to 30w

PURCHASE INFO

Item	Item Code	Designation	Diameter (nom)	Weight (Kg/Km)	Packaging
KCU64PLZHDGR5	U0102006	Cat6 cable 4 pairs U/UTP awg24 LSZH Dca grey	5.3mm	35	D500M
KCU64PLZHDGRB	U0102007	Cat6 cable 4 pairs U/UTP awg24 LSZH Dca grey	5.3mm	35	B305M

KCU6xPL

Cat6 cable U/UTP PVC Eca 4 pairs, AWG24



FIBER

RACKS & ACCESSORIES

COPPER

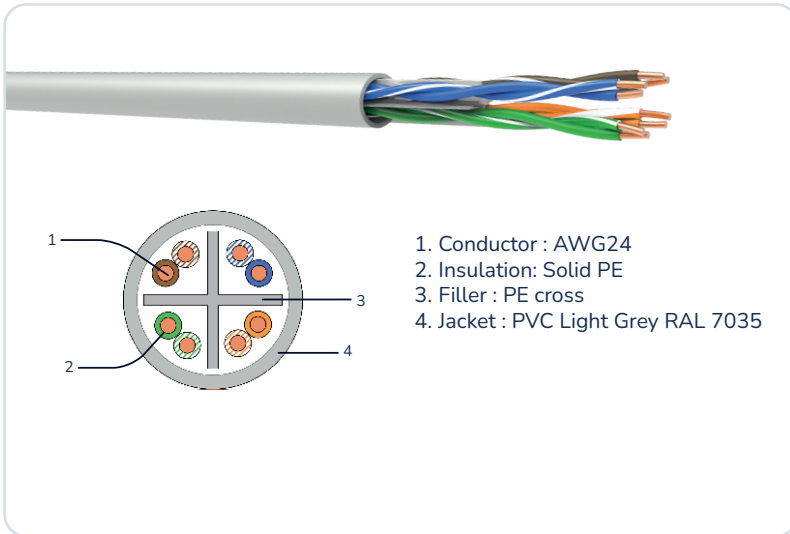

UNIK

- Compliant with ISO 11801 Class E
- PVC jacket Eca EN 50575
- Tested up to 250Mhz

Eca
 30 Year Warranty
 CE
 PoE 30w
 PVC
 Fixed installation = 8 x Ø OD
 Operating temperature: -20°C to +70°C

COMPLIANCE

Cable

IEC 61156-5:2020 Cat6
 IEC 60332-1

System

ISO/IEC 11801-1/Amd1:2025 Class E
 EN 50173-1:2018 Class E
 TIA 568.2-E Cat6

Applications

IEEE 802.3 ab/bz 1G, 2.5G & 5G BASE T
 IEEE 802.3 af/at PoE Type 1 & 2, up to 30w

PURCHASE INFO

Item	Item Code	Designation	Diameter (nom)	Weight (Kg/Km)	Packaging
KCU64PLGR5		Cat6 cable 4 pairs U/UTP awg24 PVC Eca grey	5.3mm	36	D500M
KCU64PLGRB	U0102005	Cat6 cable 4 pairs U/UTP awg24 PVC Eca grey	5.3mm	36	B305M

KJ8FSHQEFx

Keystone jack Cat8 RJ45 fully shielded 360° Toolless

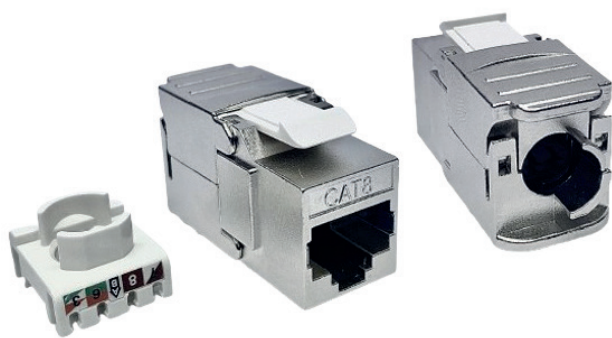

UNIK

- Robust construction in zamac
- Compact & unique design
- Fast & easy to terminate, toolless
- Conforming to Class I up to 2000 MHz
- Wide wire gauge from AWG24 to 22



COMPLIANCE

Connector

IEC 60603-7-81:2015 Cat8

System

ISO/IEC 11801-1/Amd1:2025 Class I
TIA568.2-E Cat8

Applications

IEEE 802.3 bq 25G BASE T & 40G Base T
IEEE 802.3 af/at/bt PoE Type 1 to 4, up to 90w

PURCHASE INFO

Item	Item Code	Designation	Packing
KJ8FSHQEF1		Keystone jack Cat8 shielded 360° toolless	unit
KJ8FSHQEF8		Keystone jack Cat8 shielded 360° toolless	Eco box of 8 pcs
KJ8FSHQEF24	U0204001	Keystone jack Cat8 shielded 360° toolless	Eco box of 24 pcs

KJ6AFSHQEFx

Keystone jack Cat6a RJ45 fully shielded 360° Toolless



FIBER

RACKS & ACCESSORIES

COPPER

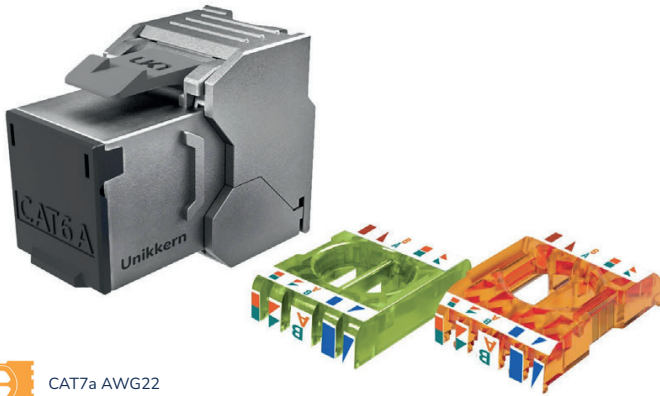

- CAT7a AWG22
- CAT6a/CAT7 AWG 24/23
- CAT6a/CAT7 AWG26 Stranded

UNIK

- Component certified Cat6a ISO
- Compliance with IEC 60512-99-002 2A verified by DELTA force
- Fast & easy to terminate, toolless
- Conforming to Class Ea up to 500 MHz
- Integrated anti-dust shutter



COMPLIANCE

Connector

IEC 60603-7-51:2010 Cat6a
IEC 60512-99-002 2A
(Contact endurance test)

System

ISO/IEC 11801-1/Amd1:2025 Class Ea
EN 50173-1:2018 Class Ea
TIA 568.2-E Cat6a

Applications

IEEE 802.3 an 10G BASE T
IEEE 802.3 af/at/bt PoE Type 1 to 4, up to 90w

PURCHASE INFO

Item	Item Code	Designation	Packing
KJ6AFSHQEF1	U0203008	Keystone jack Cat6a shielded 360° toolless	Eco bag of 1pc
KJ6AFSHQEF8	U0203010	Keystone jack Cat6a shielded 360° toolless	Eco box of 8 pcs
KJ6AFSHQEF24	U0203009	Keystone jack Cat6a shielded 360° toolless	Eco box of 24 pcs

KJ6AUHQx

Keystone jack Cat.6a RJ45 unshielded Toolless

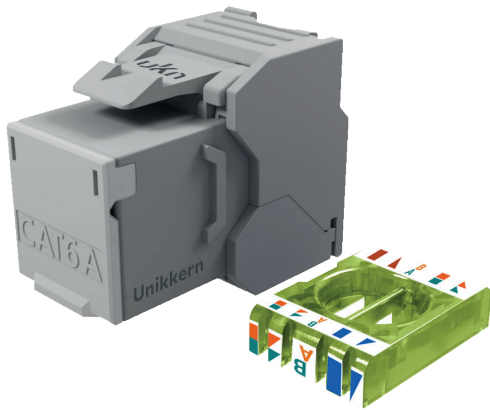

Cat6a AWG 23

UNIK

- Component certified Cat6a by Intertek
- Fast & easy to terminate, toolless
- Conforming to Class Ea up to 500 MHz
- Integrated anti-dust shutter



COMPLIANCE

Connectors

IEC 60603-7-41:2010 Cat6a

System

ISO/IEC 11801-1/Amd1:2025 Class Ea
 EN 50173-1:2018 Class Ea
 TIA 568.2-E Cat6a

Applications

IEEE 802.3 an 10G BASE T
 IEEE 802.3 af/at/bt PoE Type 1 to 4, up to 90w

PURCHASE INFO

Item	Item Code	Designation	Packing
KJ6AUHQEF1	U0203013	Keystone jack Cat6a unshielded toolless	Eco bag of 1 pc
KJ6AUHQEF24	U0203012	Keystone jack Cat6a unshielded toolless	Eco box of 24 pcs

KJ6FSxHQ

Keystone jack Cat.6 RJ45 fully shielded 360° Tooless

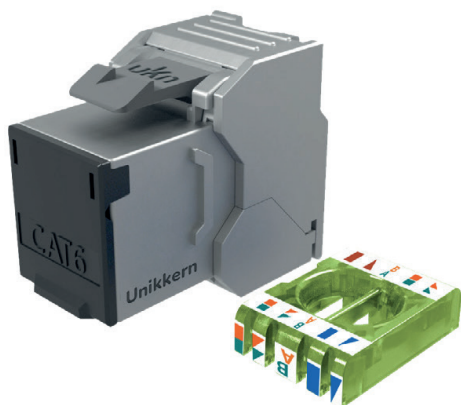

Cat6 AWG 24 & 23

UNIK

- Component certified by Intertek
- Compact & unique design
- Fast & easy to terminate, tooless
- Conforming to Class E up to 250 MHz
- Integrated anti-dust shutter



COMPLIANCE

Connectors

IEC 60603-7-5:2010 Cat6

System

ISO/IEC 11801-1/Amd1:2025 Class E

EN 50173-1:2018 Class E

TIA 568.2-E Cat6

Applications

IEEE 802.3 ab/bz 1G, 2.5G & 5G BASE T

IEEE 802.3 af/at/bt PoE Type 1,2 & 3 up to 60w

PURCHASE INFO

Item	Item Code	Designation	Packing
KJ6FSHQEF1		Keystone jack Cat6 shielded 360° tooless ETL Certified	Individual Eco bag
KJ6FSHQEF8	U0202005	Keystone jack Cat6 shielded 360° tooless ETL Certified	Eco box of 8 pcs
KJ6FSHQEF24	U0202004	Keystone jack Cat6 shielded 360° tooless ETL Certified	Eco box of 24 pcs

KJ6FSx

Keystone jack Cat.6 RJ45 fully shielded 360° Tooless

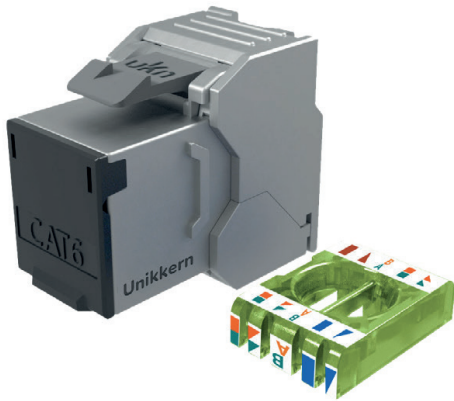

Cat6 AWG 24 & 23

UNIK

- Compact & unique design
- Fast & easy to terminate, tooless
- Conforming to Class E up to 250 MHz
- Integrated anti-dust shutter



COMPLIANCE

Connectors

IEC 60603-7-5:2010 Cat6

System

ISO/IEC 11801-1/Amd1:2025 Class E

EN 50173-1:2018 Class E

TIA 568.2-E Cat6

Applications

IEEE 802.3 ab 1000BASE T

IEEE 802.3 af/at PoE Type 1 & 2
up to 30w

PURCHASE INFO

Item	Item Code	Designation	Packing
KJ6FSEF1	U0202001	Keystone jack Cat6 shielded 360° tooless	Individual Eco bag
KJ6FSEF8	U0202003	Keystone jack Cat6 shielded 360° tooless	Eco box of 8 pcs
KJ6FSEF24	U0202002	Keystone jack Cat6 shielded 360° tooless	Eco box of 24 pcs

KJ6UxHQ

Keystone jack Cat.6 RJ45 unshielded Toolless

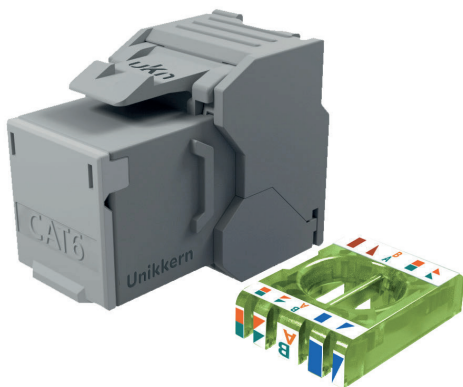

Cat6 AWG 24 & 23

UNIK

- Component certified by Intertek
- Compact & unique design
- Fast & easy to terminate, toolless
- Conforming to Class E up to 250 MHz
- Integrated anti-dust shutter



COMPLIANCE

Connectors

IEC 60603-7-4:2010 Cat6

System

ISO/IEC 11801-1/Amd1:2025 Class E

EN 50173-1:2018 Class E

TIA 568.2-E Cat6

Applications

IEEE 802.3 ab/bz 1G, 2.5G & 5G BASE T

IEEE 802.3 af/at/bt PoE Type 1,2 & 3 up to 60w

PURCHASE INFO

Item	Item Code	Designation	Packing
KJ6UHQEF1		Keystone jack Cat6 unshielded toolless ETL Certified	Individual Eco bag
KJ6UHQEF8		Keystone jack Cat6 unshielded toolless ETL Certified	Eco box of 8 pcs
KJ6UHQEF24	U0202009	Keystone jack Cat6 unshielded toolless ETL Certified	Eco box of 24 pcs

KJ6U180Dx

Keystone jack Cat.6 RJ45 unshielded 180 degrees DUAL IDC

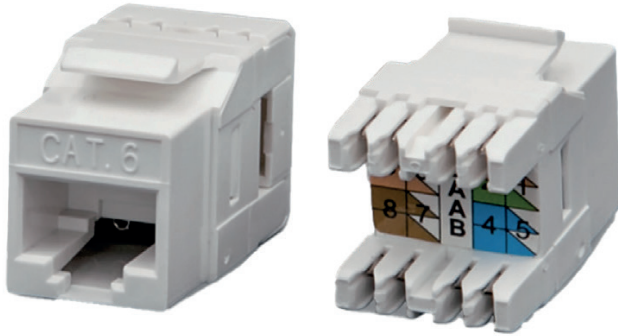

UNIK

- Compact & unique design
- Dual IDC krone & 110
- Conforming to Class E up to 250 MHz
- Include a cap to prevent disconnection



COMPLIANCE

Connectors

IEC 60603-7-4:2010 Cat6

System

ISO/IEC 11801-1/Amd1:2025 Class E
 EN 50173-1:2018 Class E
 TIA 568.2-E Cat6

Applications

IEEE 802.3 ab 1000BASE T
 IEEE 802.3 af/at PoE Type 1 & 2
 up to 30w

PURCHASE INFO

Item	Item Code	Designation	Packing
KJ6U180DEF1		Keystone jack Cat6 unshielded 180°	Individual Eco Bag
KJ6U180DEF24	U0202006	Keystone jack Cat6 unshielded 180°	Eco box of 24 pcs

KJ6Ux

Keystone jack Cat.6 RJ45 unshielded Toolless



FIBER

RACKS & ACCESSORIES

COPPER

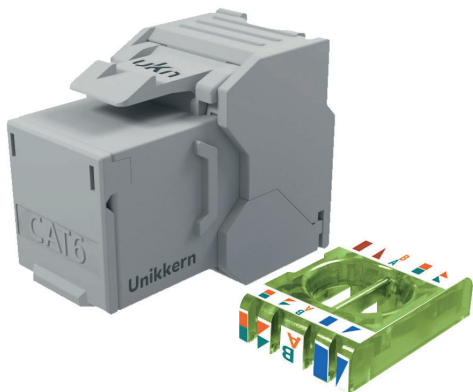

Cat6 AWG 24 & 23

UNIK

- Compact & unique design
- Fast & easy to terminate, toolless
- Conforming to Class E up to 250 MHz
- Integrated anti-dust shutter



COMPLIANCE

Connectors

IEC 60603-7-4:2010 Cat6

System

ISO/IEC 11801-1/Amd1:2025 Class E

EN 50173-1:2018 Class E

TIA 568.2-E Cat6

Applications

IEEE 802.3 ab 1000BASE T

IEEE 802.3 af/at PoE Type 1 & 2
up to 30w

PURCHASE INFO

Item	Item Code	Designation	Packing
KJ6UEF1		Keystone jack Cat6 unshielded toolless	Individual Eco Bag
KJ6UEF8		Keystone jack Cat6 unshielded toolless	Eco box of 8 pcs
KJ6UEF24	U0202008	Keystone jack Cat6 unshielded toolless	Eco box of 24 pcs

KMP8EFx

Field termination plug Cat8 360° shielded



UNIK

- Supports transfer speeds up to 40 Gbps
- Channel link up to 30 meters
- Compact & unique design
- Fast & easy to terminate, toolless
- Conforming to Class I up to 2000 MHz Cat8.1 360° shielded
- Support solid wire from AWG26 to 22



COMPLIANCE

Connector

IEC 60603-7-81:2015 Cat8

System

ISO/IEC 11801-1/Amd1:2025 Class I
TIA568.2-E Cat8

Applications

IEEE 802.3 bq 25G BASE T & 40G Base T
IEEE 802.3 af/at/bt PoE Type 1 to 4, up to 90w

PURCHASE INFO

Item	Item Code	Designation	Packing
KMP8EF1		Field termination plug Cat8 shielded	Individual Eco Bag

KMP6AFSXx

Cat6a 360° Extra small Shielded Field Connector



FIBER

RACKS & ACCESSORIES

COPPER



UNIK

- Supports data transfer speeds up to 10 Gbps
- Channel & Link certified by Intertek
- Compact and unique design
- Quick and easy tool-free connection
- Supports solid wires from AWG26 to 23



COMPLIANCE

Connectors

IEC 60603-7-51:2010 Cat6a

System

ISO/IEC 11801-1/Amd1:2025 Class Ea

EN 50173-1:2018 Class Ea

TIA 568.2-E Cat6a

Applications

IEEE 802.3 an 10G BASE T

IEEE 802.3 af/at/bt PoE Type 1 to 4, up to 90w

PURCHASE INFO

Item	Item Code	Designation	Packing
KMP6AFSXSEF1	U0205004	Cat6a 360° Extra small shielded field connector	Individual Eco Bag
KMP6AFSXSEF8		Cat6a 360° Extra small shielded field connector	Eco bag of 8

KMP6AFSx

Cat6a 360° Shielded Field Connector

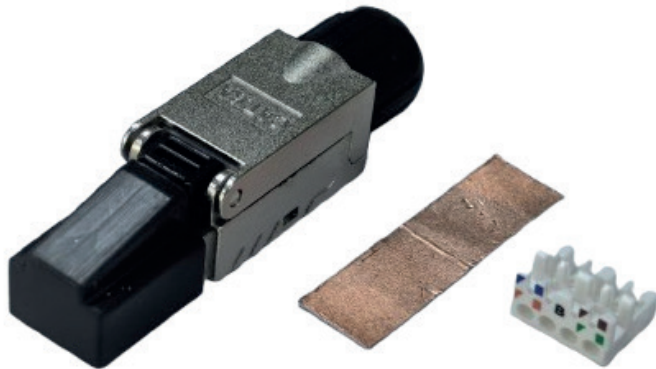

UNIK

- Supports data transfer speeds up to 10 Gbps
- Compact and unique design
- Quick and easy tool-free connection
- Supports solid wires from AWG26 to 23



COMPLIANCE

Connectors

IEC 60603-7-51:2010 Cat6a

System

ISO/IEC 11801-1/Amd1:2025 Class Ea

EN 50173-1:2018 Class Ea

TIA 568.2-E Cat6a

Applications

IEEE 802.3 an 10G BASE T

IEEE 802.3 af/at/bt PoE Type 1 to 4, up to 90w

PURCHASE INFO

Item	Item Code	Designation	Packing
KMP6AFSEF1	U0205006	Cat6a 360° shielded field connector	Individual Eco Bag
KMP6AFSEF8		Cat6a 360° shielded field connector	Eco Bag of 8

KMP6AUx

Cat6a 360° Unshielded Field Connector



FIBER

RACKS & ACCESSORIES

COPPER



UNIK

- Compact and unique design
- Channel & Link certified by Intertek
- Quick and easy tool-free connection
- Supports solid wires from AWG26 to 23



COMPLIANCE

Connectors

IEC 60603-7-41:2010 Cat6a

System

ISO/IEC 11801-1/Amd1:2025 Class Ea

EN 50173-1:2018 Class Ea

TIA 568.2-E Cat6a

Applications

IEEE 802.3 an 10G BASE T

IEEE 802.3 af/at/bt PoE Type 1 to 4, up to 90w

PURCHASE INFO

Item	Item Code	Designation	Packing
t	U0205005	Cat6a 360° unshielded field connector	Individual Eco Bag
KMP6AUFE8		Cat6a 360° unshielded field connector	Eco Bag of 8

KPL45U6AEP

Cat6a Unshielded Passthrough Modular Plug

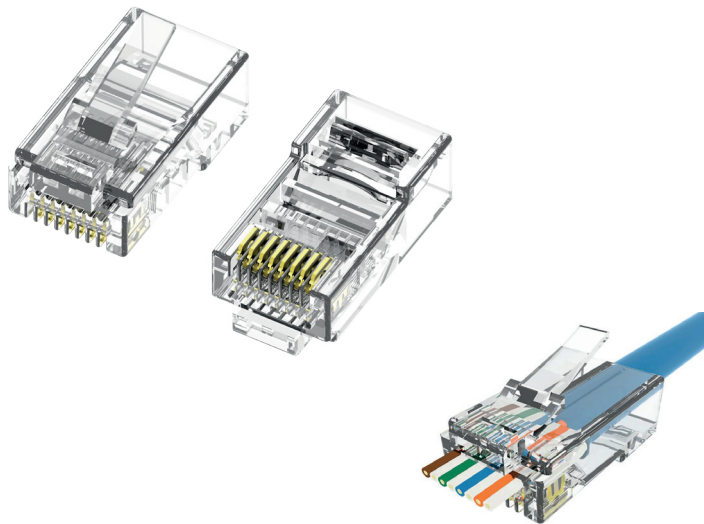

UNIK

- Supports data transfer speeds up to 10 Gbps
- Compact and unique design
- Quick and easy tool-free connection
- Supports solid wires from AWG26 to 23
- 50U Gold plating



COMPLIANCE

Connectors

IEC 60603-7-41:2010 Cat6a
UL94V0

System

ISO/IEC 11801-1/Amd1:2025 Class Ea
EN 50173-1:2018 Class Ea
TIA 568.2-E Cat6a

Applications

IEEE 802.3 an 10G BASE T
IEEE 802.3 af/at/bt PoE Type 1 to 4, up to 90w

PURCHASE INFO

Item	Item Code	Designation	Packing
KPL45U6AEP	U0206009	Cat6a Unshielded passthrough modular plug	Bag of 100 pc

KPL45U6EP

Cat6 Unshielded Passthrough Modular Plug



FIBER

RACKS & ACCESSORIES

COPPER

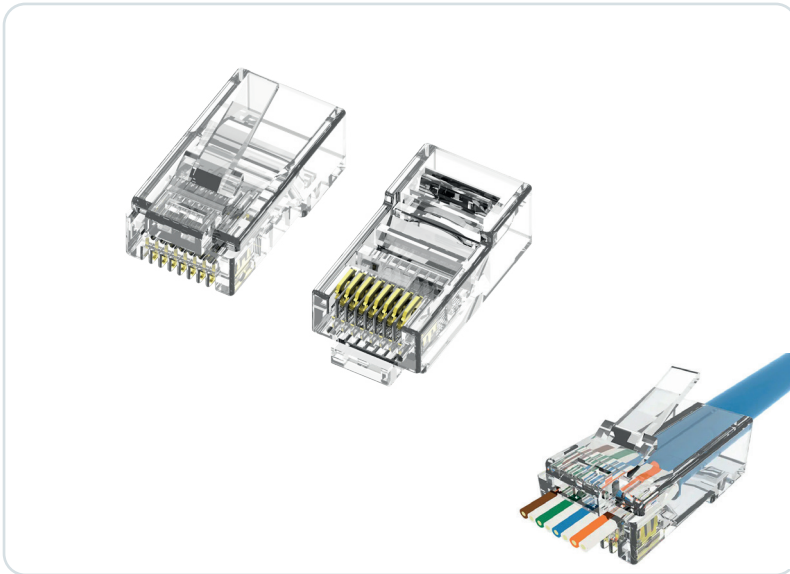

UNIK

- Supports data transfer speeds up to 1 Gbps
- Compact and unique design
- Quick and easy tool-free connection
- Supports solid wires from AWG23 to 26



COMPLIANCE

Connectors

IEC 60603-7-4:2010 Cat6
UL94V0

System

ISO/IEC 11801-1/Amd1:2025 Class E
EN 50173-1:2018 Class E
TIA 568.2-E Cat6

Applications

IEEE 802.3 ab 1000BASE T
IEEE 802.3 af/at PoE Type 1 &2
up to 30w

PURCHASE INFO

Item	Item Code	Designation	Packing
KPL45U6EP		Cat6 Unshielded passthrough modular plug	Bag of 100 pc

KPL45S6AEP

Cat6a Shielded passthrough Modular Plug

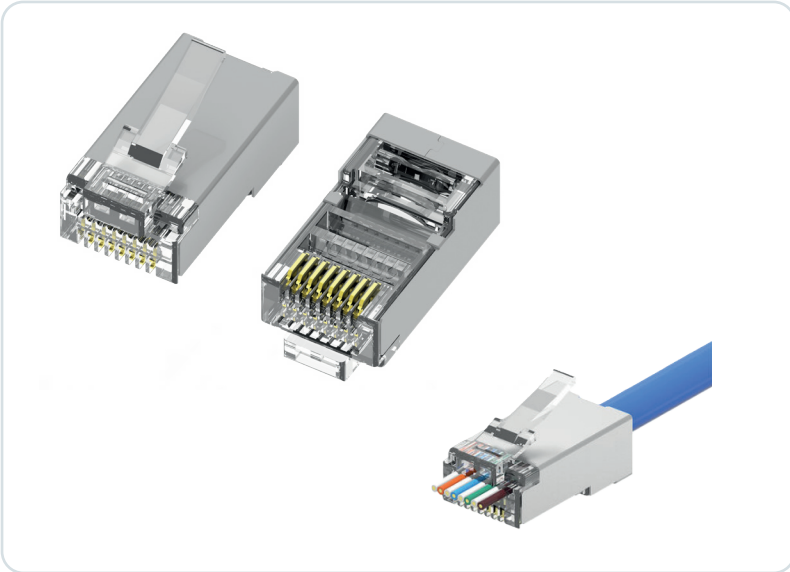

✓ UNIK

- Supports data transfer speeds up to 10 Gbps
- Compact and unique design
- Quick and easy tool-free connection
- Supports solid wires from AWG26 to 23
- 50U Gold plating



● COMPLIANCE

Connectors

IEC 60603-7-51:2010 Cat6a
UL94V0

System

ISO/IEC 11801-1/Amd1:2025 Class Ea
EN 50173-1:2018 Class Ea
TIA 568.2-E Cat6a

Applications

IEEE 802.3 an 10G BASE T
IEEE 802.3 af/at/bt PoE Type 1 to 4, up to 90w

● PURCHASE INFO

Item	Item Code	Designation	Packing
KPL45S6AEP	U0206008	Cat6a shielded passthrough modular plug	Bag of 100 pc

KPL45S6EP

Cat6 shielded passthrough Modular Plug



FIBER

RACKS & ACCESSORIES

COPPER



UNIK

- Supports data transfer speeds up to 1 Gbps
- Compact and unique design
- Quick and easy tool-free connection
- Supports solid wires from AWG23 to 26



COMPLIANCE

Connectors

IEC 60603-7-5:2010 Cat6
UL94V0

System

ISO/IEC 11801-1/Amd1:2025 Class E
EN 50173-1:2018 Class E
TIA 568.2-E Cat6

Applications

IEEE 802.3 ab 1000BASE T
IEEE 802.3 af/at PoE Type 1 & 2
up to 30w

PURCHASE INFO

Item	Item Code	Designation	Packing
KPL45S6EP		Cat6 shielded passthrough modular plug	Bag of 100 pc

KPL45BITOOL

Multifonction crimping tool



✓ UNIK

- Easy and fast crimping tool
- Cut the wires simultaneously of crimping

● PURCHASE INFO

Item	Item Code	Designation	Packing
KPL45BITOOL		Multifunction crimping tool for easy pass through modular plug	Individual Eco Bag

KPL45EPBOxx

Cat6 shielded passthrough Modular Plug



✓ UNIK

- Very flexible boots
- Available in different color
- From 6.5mm to 8.5mm OD

● PURCHASE INFO

Item	Item Code	Designation	Packing
KPL45EPBOGR		Boots for RJ45 plug - Cable OD from 6.5mm to 8.5mm Grey	Bag of 100 pc
KPL45EPBOBK		Boots for RJ45 plug - Cable OD from 6.5mm to 8.5mm Black	Bag of 100 pc

KJPP1UBMCTEF



19inch 1U patch panel full metal with 24 RJ45 Keystone ports
Automatic grounding and pre-cut mounting slots



UNIK

- Elegant and minimalist design
- Automatic grounding at the front and grounding connection for shielded connectors
- Quick identification with silk screen
- Rear support bar with secure attachment in T shape
- Precut 19 inch mounting slots for quick one-hand installation
- Cage nuts and cables ties included

PURCHASE INFO

References	Item Code	Designation	Packaging
KJPP1UBMCTEF	U0501011	19 inch 1U 24 ports Keystone panel full metal	Eco box de 1p

KJPP2UBMCTEF



19inch 2U patch panel full metal with 48 RJ45 Keystone ports
Automatic grounding and pre-cut mounting slots

FIBER

RACKS & ACCESSORIES

COPPER

UNIK

- Elegant and minimalist design
- Automatic grounding at the front and grounding connection for shielded connectors
- Quick identification with silk screen
- Rear support bar with secure attachment in T shape
- Precut 19 inch mounting slots for quick one-hand installation
- Cage nuts and cables ties included



PURCHASE INFO

References	Item Code	Designation	Packaging
KJPP2UBMCTEF	U0501015	19 inch 2U 48 ports Keystone panel full metal	Eco box de 1p

KJPP1UMRNEF



19inch 1U patch panel with 24 RJ45 Keystone ports
Automatic grounding, label holders and cable management rings



UNIK

- Automatic grounding for enhanced shielding performance
- 24-port Keystone design for maximum flexibility
- Integrated cable management rings for organized routing
- Clear port identification for easy installation and maintenance
- Precut 19-inch mounting slots for quick one hand installation
- Cage nuts and cables ties included

PURCHASE INFO

References	Item Code	Designation	Packaging
KJPP1UMRNEF		19 inch 1U 24-port Keystone patch panel with automatic grounding and integrated cable management rings	Eco box of 1p

KJPP1UBCAMRNEF



19inch 1U V-shape patch panel with 24 RJ45 Keystone ports
Automatic grounding, label holders and cable management rings

FIBER

RACKS & ACCESSORIES

COPPER

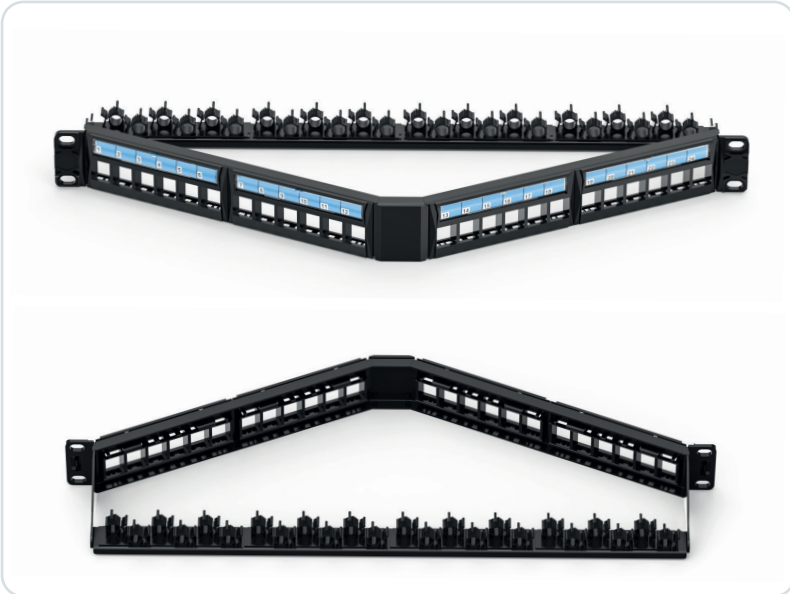

UNIK

- V-shape design for optimized cable routing
- 24-port Keystone architecture for maximum flexibility
- Integrated label holders for easy identification
- Easy maintenance with front-detachable modules
- Precut 19 inch mounting slots for quick one hand installation
- Cage nuts and cables ties included

PURCHASE INFO

References	Item Code	Designation	Packaging
KJPP1UBCAMRNEF		19 inch1U 24-port V-shape Keystone patch panel for optimized cable routing with management rings	Eco box of 1p

KJPP1UBCTEF

19inch 1U patch panel with 24 RJ45 Keystone ports
Automatic grounding and label holders



UNIK

- Elegant and minimalist design
- Automatic grounding at the front and grounding connection for shielded connectors
- Integrated polycarbonate label holders for quick identification
- Rear support bar with secure attachment
- Precut 19-inch mounting slots for quick one hand installation
- Cage nuts and cables ties included

PURCHASE INFO

References	Item Code	Designation	Packaging
KJPP1UBCTEF	U0501009	19 inch 1U 24 ports Keystone panel integrated polycarbonate label holders	Eco box of 1p

KJPP1UBCANEF



19 inch 1U V-shape patch panel with 24 RJ45 Keystone ports
Automatic grounding and pre-cut mounting slots

FIBER

RACKS & ACCESSORIES

COPPER



UNIK

- Design for High density configuration
- Automatic grounding at the front and grounding connection for shielded connectors.
- Rear support bar with secure attachment
- Precut 19 inch mounting slots for quick one hand installation
- Cage nuts and cables ties included

PURCHASE INFO

References	Item Code	Designation	Packaging
KJPP1UBCANEF	U0501007	19 inch 1U V SHAPE 24 ports Keystone panel	Eco box of 1p

KJFP4545xPANGEF



Angled faceplate 1 or 2 ports 45x45

✓ UNIK

- Inclined at 45° for better depth management
- Keystone attachment
- Integrated dust cover
- Built-in labelling
- White RAL 9003



● PURCHASE INFO

Item	Item Code	Designation	Packaging
KJFP45451PANGEF8	U0301003	Angled faceplate 1 port 45mmx45mm white	Eco-box of 8pcs
KJFP45451PANGEF48		Angled faceplate 1 port 45mmx45mm white	Eco-box of 48pcs
KKFP45452PANGEF8	U0301006	Angled faceplate 2 ports 45mmx45mm white	Eco-box of 8pcs
KJFP45452PANGEF48		Angled faceplate 2 ports 45mmx45mm white	Eco-box of 48pcs

KJFP4545xPEF

Flat faceplate 1 or 2 ports 45x45



FIBER

RACKS & ACCESSORIES

COPPER



UNIK

- Keystone attachment
- Integrated dust cover
- Built-in labelling with transparent flapping windows
- White RAL 9003

PURCHASE INFO

Item	Item Code	Designation	Packaging
KJFP45451PEF8	U0301004	Flat faceplate 1 port 45mmx45mm white	Eco-box of 8pcs
KJFP45451PEF48		Flat faceplate 1 port 45mmx45mm white	Eco-box of 48pcs
KJFP45452PEF8	U0301007	Flat faceplate 2 ports 45mmx45mm white	Eco-box of 8pcs
KJFP45452PEF48		Flat faceplate 2 ports 45mmx45mm white	Eco-box of 48pcs

KJFP4545xPABEF

Antibacterial flat faceplates 45x45 1 or 2 ports

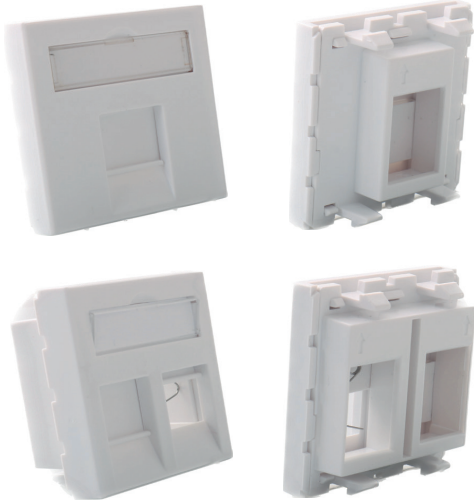

UNIK

- Antibacterial according to ISO 22186 certified by the SGS laboratory
- Keystone attachment
- Integrated dust shutter
- Rotative label holder
- White RAL 9003

PURCHASE INFO

Items	Item Code	Designation	Packaging
KJFP45451PABEF8	U0301002	Antibacterial flat faceplate 1 port 45mmx45mm white	Eco-box of 8pcs
KJFP45451PABEF48		Antibacterial flat faceplate 1 port 45mmx45mm white	Eco-box of 48pcs
KJFP45452PABEF8	U0301005	Antibacterial flat faceplate 2 ports 45mmx45mm white	Eco-box of 8pcs
KJFP45452PABEF48		Antibacterial flat faceplate 2 ports 45mmx45mm white	Eco-box of 48pcs

KWP8686xPEF

Flat wallplate 1 or 2 ports 86x86



FIBER

RACKS & ACCESSORIES

COPPER



UNIK

- Keystone attachment
- Integrated dust cover
- Built-in labelling with transparent flapping windows
- White RAL 9010

PURCHASE INFO

Items	Item Code	Designation	Packaging
KWP86861PEF8	U0301010	Flat wallplate 1 port 86mmx86mm white	Eco-box of 8pcs
KWP86862PEF8	U0301011	Flat wallplate 2 ports 86mmx86mm white	Eco-box of 8pcs

KWP8686AxPEF

Angled Flat wallplate 1 or 2 ports 86x86



✓ UNIK

- Keystone attachment
- Integrated dust cover
- Built-in labelling with transparent flapping windows
- White RAL 9010

● PURCHASE INFO

Items	Item Code	Designation	Packaging
KWP8686A1PEF8	U0301012	Angled wallplate 1 port 86mmx86mm white	Eco-box of 8pcs
KWP8686A2PEF8	U0301013	Angled wallplate 2 ports 86mmx86mm white	Eco-box of 8pcs

KSB8686xPEF

Surface mounting box 86x86



FIBER

RACKS & ACCESSORIES

COPPER



UNIK

- Available in 36 or 45mm depth
- Screws for the wall plate are included
- White RAL 9010

PURCHASE INFO

Items	Item Code	Designation	Packaging
KSB868645EF	U0301009	Surface mounting box 86mmx86mm depth 45mm white	Eco-box of 8pcs
KSB868636EF	U0301008	Surface mounting box 86mmx86mm depth 36mm white	Eco-box of 8pcs

KPSF6AZHx

Patchcords CAT6A S/FTP LSZH, AWG26



UNIK

- Perfect EMI thanks to a braid & shield design
- Channel certified by Intertek
- Snagless boots to protect RJ45 plug
- LSZH jacket to respect low smoke emission
- Available in multiple lengths and colors



COMPLIANCE

Connectors

IEC 60603-7-51:2010 Cat6a

System

ISO/IEC 11801-1/Amd1:2025 Class Ea

EN 50173-1:2018 Class Ea

TIA 568.2-E Cat6a

Applications

IEEE 802.3 an 10G BASE T

IEEE 802.3 af/at/bt PoE Type 1 to 4, up to 90w

PURCHASE INFO

Length	Item	Item Code	Description	Packing
0.5m	KPSF6AZH05EF	U0405002	Cat6a RJ45 patchcord S/FTP awg26 0.5m LSZH grey	Eco-friendly paper bag of 1 pc
1m	KPSF6AZH1EF	U0405005	Cat6a RJ45 patchcord S/FTP awg26 1m LSZH grey	Eco-friendly paper bag of 1 pc
2m	KPSF6AZH2EF	U0405007	Cat6a RJ45 patchcord S/FTP awg26 2m LSZH grey	Eco-friendly paper bag of 1 pc
3m	KPSF6AZH3EF	U0405008	Cat6a RJ45 patchcord S/FTP awg26 3m LSZH grey	Eco-friendly paper bag of 1 pc
5m	KPSF6AZH5EF	U0405009	Cat6a RJ45 patchcord S/FTP awg26 5m LSZH grey	Eco-friendly paper bag of 1 pc
10m	KPSF6AZH10EF	U0405003	Cat6a RJ45 patchcord S/FTP awg26 10m LSZH grey	Eco-friendly paper bag of 1 pc
15m	KPSF6AZH15EF	U0405004	Cat6a RJ45 patchcord S/FTP awg26 15m LSZH grey	Eco-friendly paper bag of 1 pc
20m	KPSF6AZH20EF	U0405006	Cat6a RJ45 patchcord S/FTP awg26 20m LSZH grey	Eco-friendly paper bag of 1 pc
25m	KPSF6AZH25EF		Cat6a RJ45 patchcord S/FTP awg26 25m LSZH grey	Eco-friendly paper bag of 1 pc
30m	KPSF6AZH30EF	U0405024	Cat6a RJ45 patchcord S/FTP awg26 30m LSZH grey	Eco-friendly paper bag of 1 pc
50m	KPSF6AZH50EF	U0405026	Cat6a RJ45 patchcord S/FTP awg26 50m LSZH grey	Eco-friendly paper bag of 1 pc
70m	KPSF6AZH70EF		Cat6a RJ45 patchcord S/FTP awg26 70m LSZH grey	Eco-friendly paper bag of 1 pc

KPSF6AZHSLx

SLIM patchcords CAT6A S/FTP LSZH, AWG30



UNIK

- Ultra-slim (OD 4.6mm) for high-density
- S/FTP shielding for maximum EMI protection
- AWG30 stranded for flexibility & space saving
- Channel performance certified – Class Ea
- Snagless boot design & LSZH jacket
- Available in multiple lengths and colors



COMPLIANCE

Connectors

IEC 60603-7-51:2010 Cat6a

System

ISO/IEC 11801-1/Amd1:2025 Class Ea

EN 50173-1:2018 Class Ea

TIA 568.2-E Cat6a

Applications

IEEE 802.3 an 10G BASE T

IEEE 802.3 af/at PoE Type 1 & 2, up to 30w

PURCHASE INFO

Length	Item	Item Code	Description	Packing
0.5m	KPSF6AZHSL05EF	U0405018	Slim cat6a RJ45 patchcord S/FTP awg30 0.5m LSZH grey	Eco-friendly paper bag of 1 pc
1m	KPSF6AZHSL1EF	U0405020	Slim cat6a RJ45 patchcord S/FTP awg30 1m LSZH grey	Eco-friendly paper bag of 1 pc
2m	KPSF6AZHSL2EF	U0405021	Slim cat6a RJ45 patchcord S/FTP awg30 2m LSZH grey	Eco-friendly paper bag of 1 pc
3m	KPSF6AZHSL3EF	U0405022	Slim cat6a RJ45 patchcord S/FTP awg30 3m LSZH grey	Eco-friendly paper bag of 1 pc
5m	KPSF6AZHSL5EF	U0405023	Slim cat6a RJ45 patchcord S/FTP awg30 5m LSZH grey	Eco-friendly paper bag of 1 pc
10m	KPSF6AZHSL10EF	U0405019	Slim cat6a RJ45 patchcord S/FTP awg30 10m LSZH grey	Eco-friendly paper bag of 1 pc

KPUU6AZHx

Patchcords CAT6A U/UTP LSZH, AWG24



UNIK

- Compliant with Cat6a & exceeding 500Mhz test
- Channel certified by Intertek
- Snagless boots to protect RJ45 plug
- LSZH jacket to respect low smoke emission
- Available in multiple lengths and colors



COMPLIANCE

Connectors

IEC 60603-7-41:2010 Cat6a

System

ISO/IEC 11801-1/Amd1:2025 Class Ea
 EN 50173-1:2018 Class Ea
 TIA 568.2-E Cat6a

Applications

IEEE 802.3 an 10G BASE T
 IEEE 802.3 af/at/bt PoE Type 1 to 4, up to 90w

PURCHASE INFO

Length	Item	Item Code	Description	Packing
0.5m	KPUU6AZH05EF	U0406002	Cat6a RJ45 patchcord U/UTP awg24 0.5m LSZH grey	Eco-friendly paper bag
1m	KPUU6AZH1EF	U0406004	Cat6a RJ45 patchcord U/UTP awg24 1m LSZH grey	Eco-friendly paper bag
2m	KPUU6AZH2EF	U0406005	Cat6a RJ45 patchcord U/UTP awg24 2m LSZH grey	Eco-friendly paper bag
3m	KPUU6AZH3EF	U0406006	Cat6a RJ45 patchcord U/UTP awg24 3m LSZH grey	Eco-friendly paper bag
5m	KPUU6AZH5EF	U0406007	Cat6a RJ45 patchcord U/UTP awg24 5m LSZH grey	Eco-friendly paper bag
10m	KPUU6AZH10EF	U0406003	Cat6a RJ45 patchcord U/UTP awg24 10m LSZH grey	Eco-friendly paper bag

KPUU6AZHSLx

SLIM patchcords CAT6A U/UTP LSZH, AWG28



FIBER

RACKS & ACCESSORIES

COPPER

UNIK

- Ultra-slim (OD 3.8mm) for high-density & airflow
- AWG28 stranded for enhanced flexibility
- Optimized for DC patching (rack & ToR)
- Lightweight and easy cable management
- Channel performance certified – Class Ea
- Snagless boot design & LSZH jacket
- Available in multiple lengths and colors



COMPLIANCE

Connectors

IEC 60603-7-41:2010 Cat6a

System

ISO/IEC 11801-1/Amd1:2025 Class Ea
 EN 50173-1:2018 Class Ea
 TIA 568.2-E Cat6a

Applications

IEEE 802.3 an 10G BASE T
 IEEE 802.3 af/at/bt PoE Type 1 & 2 up to 30w

PURCHASE INFO

Length	Item	Item Code	Description	Packing
0.5m	KPUU6AZHSL05EF	U0406009	Slim cat6a RJ45 patchcord U/UTP awg28 0.5m LSZH grey	Eco-friendly paper bag
1m	KPUU6AZHSL1EF	U0406011	Slim cat6a RJ45 patchcord U/UTP awg28 1m LSZH grey	Eco-friendly paper bag
2m	KPUU6AZHSL2EF	U0406012	Slim cat6a RJ45 patchcord U/UTP awg28 2m LSZH grey	Eco-friendly paper bag
3m	KPUU6AZHSL3EF	U0406013	Slim cat6a RJ45 patchcord U/UTP awg28 3m LSZH grey	Eco-friendly paper bag
5m	KPUU6AZHSL5EF	U0406014	Slim cat6a RJ45 patchcord U/UTP awg28 5m LSZH grey	Eco-friendly paper bag
10m	KPUU6AZHSL10EF	U0406010	Slim cat6a RJ45 patchcord U/UTP awg28 10m LSZH grey	Eco-friendly paper bag

KPUU6ZHx

Patchcords CAT6 U/UTP LSZH, AWG24



UNIK

- Compliant with Cat6 & exceeding 250Mhz test
- Channel certified by Intertek
- Snagless boots to protect RJ45 plug
- LSZH jacket to respect low smoke emission
- Available in multiple lengths and colors



COMPLIANCE

Connectors

IEC 60603-7-4:2010 Cat6

System

ISO/IEC 11801-1/Amd1:2025 Class E
 EN 50173-1:2018 Class E
 TIA 568.2-E Cat6

Applications

IEEE 802.3 ab/bz 1G, 2.5G & 5G BASE T
 IEEE 802.3 af/at/bt PoE Type 1,2 & 3 up to 60w

PURCHASE INFO

Length	Item	Item Code	Description	Packing
0.5m	KPUU6ZH05EF	U0404002	Cat6 RJ45 patchcord U/UTP awg24 0.5m LSZH grey	Eco-friendly paper bag
1m	KPUU6ZH1EF	U0404004	Cat6 RJ45 patchcord U/UTP awg24 1m LSZH grey	Eco-friendly paper bag
2m	KPUU6ZH2EF	U0404005	Cat6 RJ45 patchcord U/UTP awg24 2m LSZH grey	Eco-friendly paper bag
3m	KPUU6ZH3EF	U0404006	Cat6 RJ45 patchcord U/UTP awg24 3m LSZH grey	Eco-friendly paper bag
5m	KPUU6ZH5EF	U0404007	Cat6 RJ45 patchcord U/UTP awg24 5m LSZH grey	Eco-friendly paper bag
10m	KPUU6ZH10EF	U0404003	Cat6 RJ45 patchcord U/UTP awg24 10m LSZH grey	Eco-friendly paper bag

Listening

Deep understanding
of client needs
and market demands.

Agility

Quick response to
requests with dedicated
expert contacts.

Simplification

Streamlining communication,
development,
and product usage.

Reliability

Maintaining high product
standards and a reliable
supply chain.

The logo for Unikkern features the word 'unikkern' in a white, lowercase, sans-serif font. A small green vertical bar is positioned above the 'i'.

Unikkern

A brand of

The logo for syskern features the word 'syskern' in a white, lowercase, sans-serif font. A small green vertical bar is positioned above the 'i'.

www.unikkern.com

31 rue Tronchet
75008 Paris